

# Aerodynamics of Flight

## Forces Acting on the Aircraft

Thrust, drag, lift, and weight are forces that act upon all aircraft in flight. Understanding how these forces work and knowing how to control them with the use of power and flight controls are essential to flight. This chapter discusses the aerodynamics of flight—how design, weight, load factors, and gravity affect an aircraft during flight maneuvers.

The four forces acting on an aircraft in straight-and-level, unaccelerated flight are thrust, drag, lift, and weight. They are defined as follows:

- **Thrust**—the forward force produced by the powerplant/propeller or rotor. It opposes or overcomes the force of drag. As a general rule, it acts parallel to the longitudinal axis. However, this is not always the case, as explained later.
- **Drag**—a rearward, retarding force caused by disruption of airflow by the wing, rotor, fuselage, and other protruding objects. As a general rule, drag opposes thrust and acts rearward parallel to the relative wind.
- **Lift**—is a force that is produced by the dynamic effect of the air acting on the airfoil, and acts perpendicular to the flight path through the center of lift (CL) and perpendicular to the lateral axis. In level flight, lift opposes the downward force of weight.

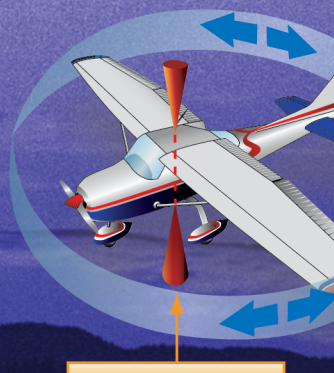
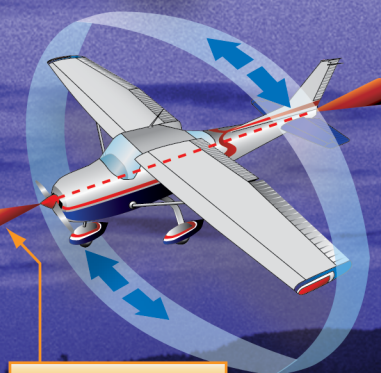
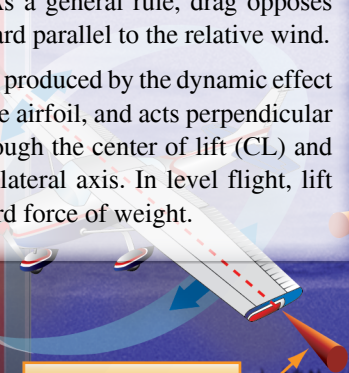
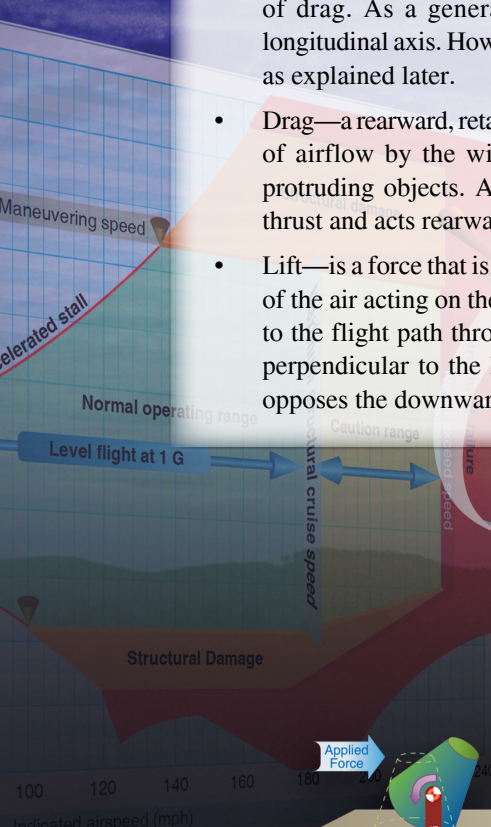
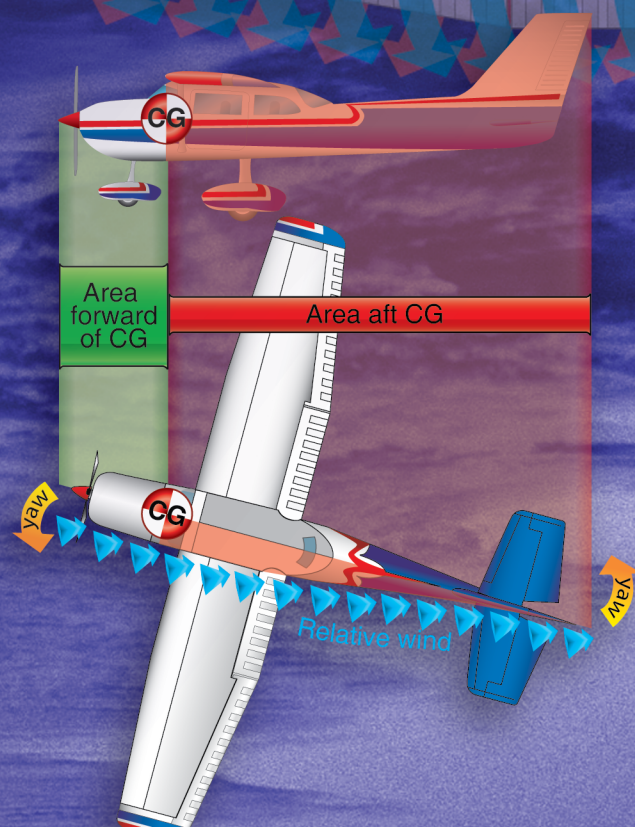

Lateral axis

Longitudinal axis

Vertical axis

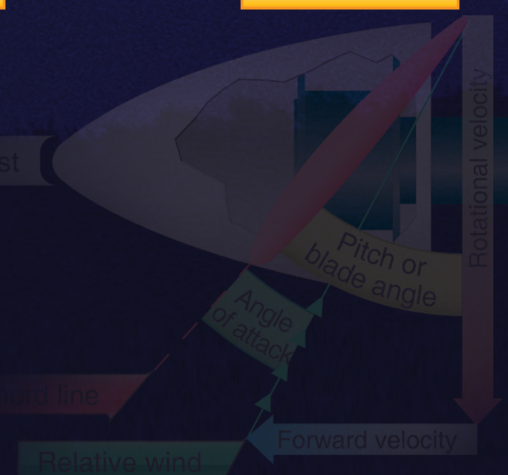
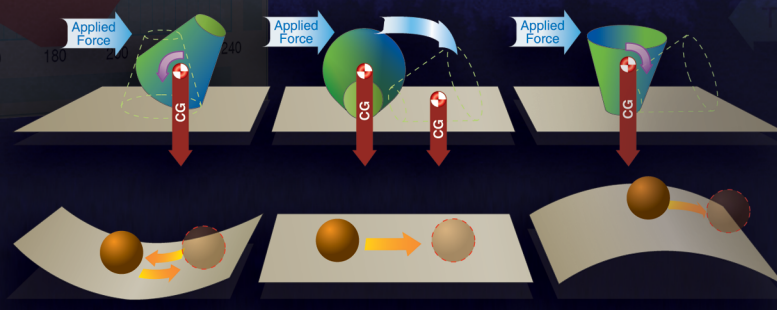

- Weight—the combined load of the aircraft itself, the crew, the fuel, and the cargo or baggage. Weight is a force that pulls the aircraft downward because of the force of gravity. It opposes lift and acts vertically downward through the aircraft’s center of gravity (CG).

In steady flight, the sum of these opposing forces is always zero. There can be no unbalanced forces in steady, straight flight based upon Newton’s Third Law, which states that for every action or force there is an equal, but opposite, reaction or force. This is true whether flying level or when climbing or descending.

It does not mean the four forces are equal. It means the opposing forces are equal to, and thereby cancel, the effects of each other. In *Figure 5-1*, the force vectors of thrust, drag, lift, and weight appear to be equal in value. The usual explanation states (without stipulating that thrust and drag do not equal weight and lift) that thrust equals drag and lift equals weight. Although true, this statement can be misleading. It should be understood that in straight, level, unaccelerated flight, it is true that the opposing lift/weight forces are equal. They are also greater than the opposing forces of thrust/drag that are equal only to each other. Therefore, in steady flight:

- The sum of all upward components of forces (not just lift) equals the sum of all downward components of forces (not just weight)
- The sum of all forward components of forces (not just thrust) equals the sum of all backward components of forces (not just drag)

This refinement of the old “thrust equals drag; lift equals weight” formula explains that a portion of thrust is directed upward in climbs and slow flight and acts as if it were lift while a portion of weight is directed backward opposite to the direction of flight and acts as if it were drag. In slow flight,

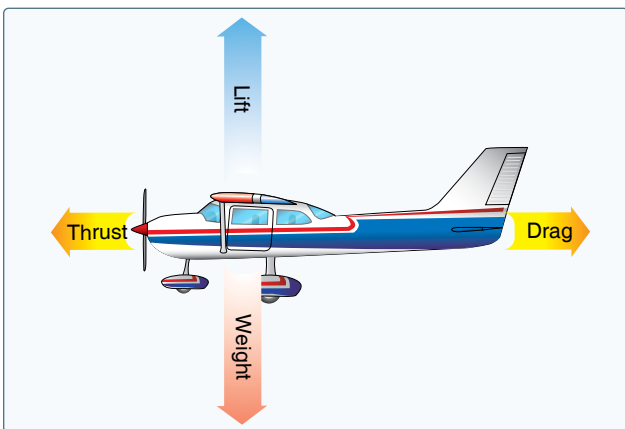

Figure 5-1. Relationship of forces acting on an aircraft.

thrust has an upward component. But because the aircraft is in level flight, weight does not contribute to drag. [*Figure 5-2*]

In glides, a portion of the weight vector is directed along the forward flight path and, therefore, acts as thrust. In other words, any time the flight path of the aircraft is not horizontal, lift, weight, thrust, and drag vectors must each be broken down into two components.

Another important concept to understand is angle of attack (AOA). Since the early days of flight, AOA is fundamental to understanding many aspects of airplane performance, stability, and control. The AOA is defined as the acute angle between the chord line of the airfoil and the direction of the relative wind.

Discussions of the preceding concepts are frequently omitted in aeronautical texts/handbooks/manuals. The reason is not that they are inconsequential, but because the main ideas with respect to the aerodynamic forces acting upon an aircraft in flight can be presented in their most essential elements without being involved in the technicalities of the aerodynamicist. In point of fact, considering only level flight, and normal climbs and glides in a steady state, it is still true that lift provided by the wing or rotor is the primary upward force, and weight is the primary downward force.

By using the aerodynamic forces of thrust, drag, lift, and weight, pilots can fly a controlled, safe flight. A more detailed discussion of these forces follows.

### Thrust

For an aircraft to start moving, thrust must be exerted and be greater than drag. The aircraft continues to move and gain speed until thrust and drag are equal. In order to maintain a

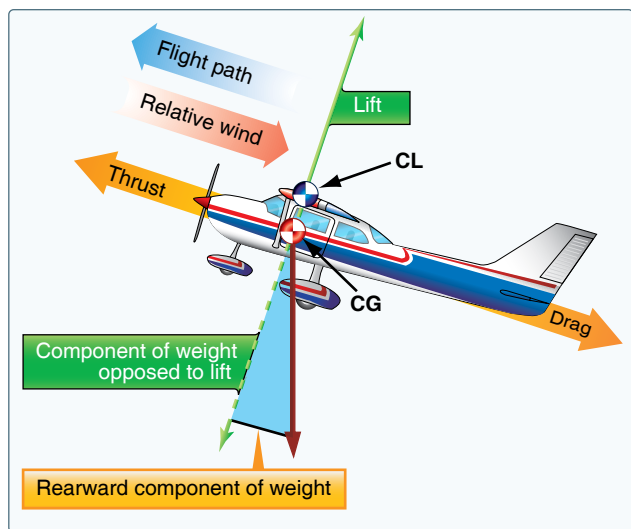

Figure 5-2. Force vectors during a stabilized climb.

constant airspeed, thrust and drag must remain equal, just as lift and weight must be equal to maintain a constant altitude. If in level flight, the engine power is reduced, the thrust is lessened, and the aircraft slows down. As long as the thrust is less than the drag, the aircraft continues to decelerate. To a point, as the aircraft slows down, the drag force will also decrease. The aircraft will continue to slow down until thrust again equals drag at which point the airspeed will stabilize.

Likewise, if the engine power is increased, thrust becomes greater than drag and the airspeed increases. As long as the thrust continues to be greater than the drag, the aircraft continues to accelerate. When drag equals thrust, the aircraft flies at a constant airspeed.

Straight-and-level flight may be sustained at a wide range of speeds. The pilot coordinates AOA and thrust in all speed regimes if the aircraft is to be held in level flight. An important fact related to the principal of lift (for a given airfoil shape) is that lift varies with the AOA and airspeed. Therefore, a large AOA at low airspeeds produces an equal amount of lift at high airspeeds with a low AOA. The speed regimes of flight can be grouped in three categories: low-speed flight, cruising flight, and high-speed flight.

When the airspeed is low, the AOA must be relatively high if the balance between lift and weight is to be maintained. [Figure 5-3] If thrust decreases and airspeed decreases, lift will become less than weight and the aircraft will start to descend. To maintain level flight, the pilot can increase the AOA an amount that generates a lift force again equal to the weight of the aircraft. While the aircraft will be flying more slowly, it will still maintain level flight. The AOA is adjusted to maintain lift equal weight. The airspeed will naturally adjust until drag equals thrust and then maintain that airspeed (assumes the pilot is not trying to hold an exact speed).

Straight-and-level flight in the slow-speed regime provides some interesting conditions relative to the equilibrium of forces. With the aircraft in a nose-high attitude, there is a vertical component of thrust that helps support it. For one thing, wing loading tends to be less than would be expected.

In level flight, when thrust is increased, the aircraft speeds up and the lift increases. The aircraft will start to climb unless the AOA is decreased just enough to maintain the relationship between lift and weight. The timing of this decrease in AOA needs to be coordinated with the increase in thrust and airspeed. Otherwise, if the AOA is decreased too fast, the aircraft will descend, and if the AOA is decreased too slowly, the aircraft will climb.

As the airspeed varies due to thrust, the AOA must also vary to maintain level flight. At very high speeds and level flight, it is even possible to have a slightly negative AOA. As thrust is reduced and airspeed decreases, the AOA must increase in order to maintain altitude. If speed decreases enough, the required AOA will increase to the critical AOA. Any further increase in the AOA will result in the wing stalling. Therefore, extra vigilance is required at reduced thrust settings and low speeds so as not to exceed the critical angle of attack. If the airplane is equipped with an AOA indicator, it should be referenced to help monitor the proximity to the critical AOA.

Some aircraft have the ability to change the direction of the thrust rather than changing the AOA. This is accomplished either by pivoting the engines or by vectoring the exhaust gases. [Figure 5-4]

### Lift

The pilot can control the lift. Any time the control yoke or stick is moved fore or aft, the AOA is changed. As the AOA increases, lift increases (all other factors being equal). When the aircraft reaches the maximum AOA, lift begins to diminish rapidly. This is the stalling AOA, known as  $C_{L-MAX}$  critical AOA. Examine Figure 5-5, noting how the  $C_L$  increases until the critical AOA is reached, then decreases rapidly with any further increase in the AOA.

Before proceeding further with the topic of lift and how it can be controlled, velocity must be discussed. The shape of the wing or rotor cannot be effective unless it continually keeps “attacking” new air. If an aircraft is to keep flying, the lift-producing airfoil must keep moving. In a helicopter or gyroplane, this is accomplished by the rotation of the rotor blades. For other types of aircraft, such as airplanes, weight-

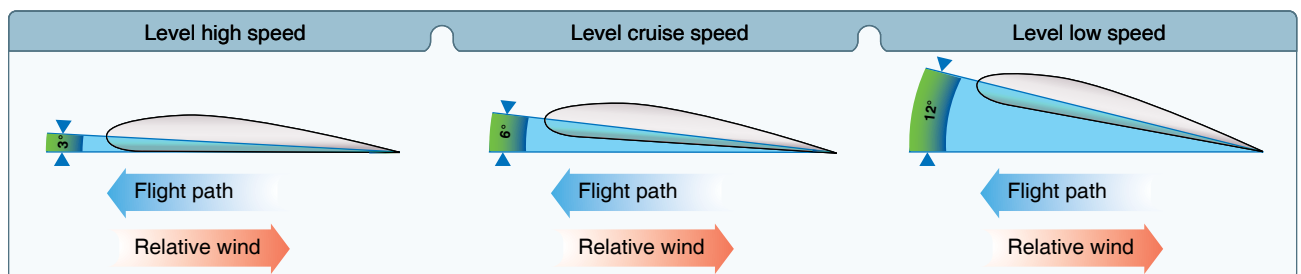

Figure 5-3. Angle of attack at various speeds.



Figure 5-4. Some aircraft have the ability to change the direction of thrust.

shift control, or gliders, air must be moving across the lifting surface. This is accomplished by the forward speed of the aircraft. Lift is proportional to the square of the aircraft's velocity. For example, an airplane traveling at 200 knots has four times the lift as the same airplane traveling at 100 knots, if the AOA and other factors remain constant.

$$L = \frac{C_L \cdot \rho \cdot V^2 \cdot S}{2}$$

The above lift equation exemplifies this mathematically and supports that doubling of the airspeed will result in four times the lift. As a result, one can see that velocity is an important component to the production of lift, which itself can be affected through varying AOA. When examining the equation, lift (L) is determined through the relationship of the air density ( $\rho$ ), the airfoil velocity (V), the surface area of the wing (S) and the coefficient of lift ( $C_L$ ) for a given airfoil.

Taking the equation further, one can see an aircraft could not continue to travel in level flight at a constant altitude and maintain the same AOA if the velocity is increased. The lift would increase and the aircraft would climb as a result of the increased lift force or speed up. Therefore, to keep the aircraft straight and level (not accelerating upward) and in a state of equilibrium, as velocity is increased, lift must be kept constant. This is normally accomplished by reducing the AOA by lowering the nose. Conversely, as the aircraft is slowed, the decreasing velocity requires increasing the AOA to maintain lift sufficient to maintain flight. There is, of course, a limit to how far the AOA can be increased, if a stall is to be avoided.

All other factors being constant, for every AOA there is a corresponding airspeed required to maintain altitude in steady, unaccelerated flight (true only if maintaining level flight). Since an airfoil always stalls at the same AOA, if increasing weight, lift must also be increased. The only

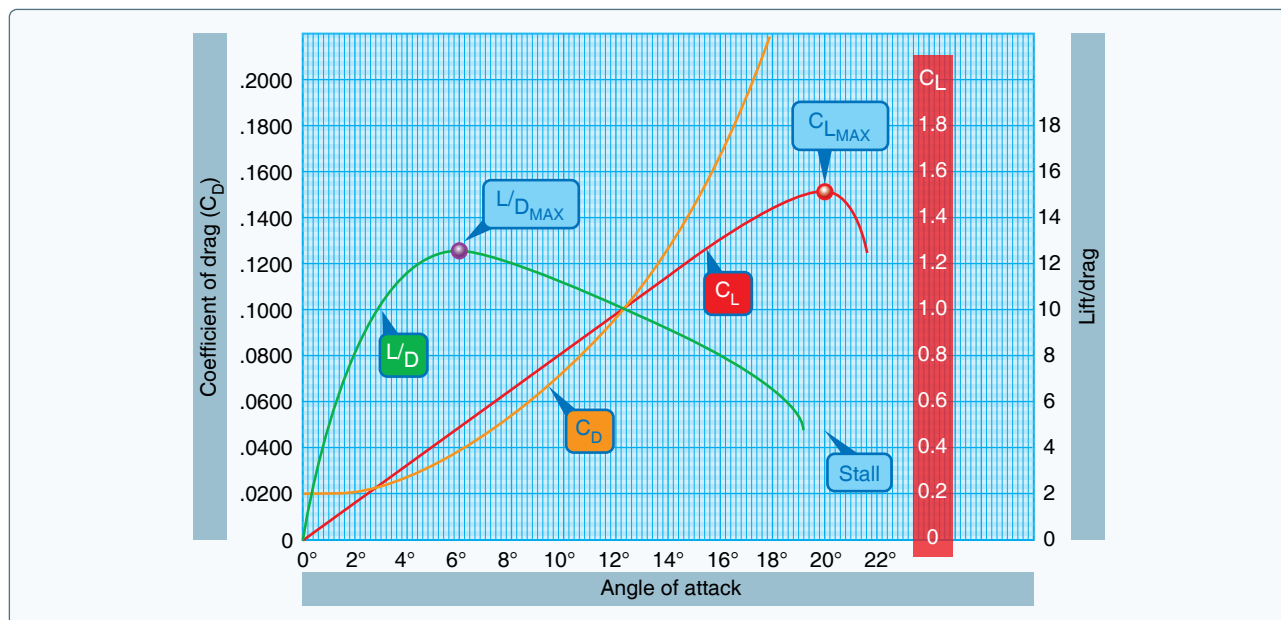

Figure 5-5. Coefficients of lift and drag at various angles of attack.

method of increasing lift is by increasing velocity if the AOA is held constant just short of the “critical,” or stalling, AOA (assuming no flaps or other high lift devices).

Lift and drag also vary directly with the density of the air. Density is affected by several factors: pressure, temperature, and humidity. At an altitude of 18,000 feet, the density of the air has one-half the density of air at sea level. In order to maintain its lift at a higher altitude, an aircraft must fly at a greater true airspeed for any given AOA.

Warm air is less dense than cool air, and moist air is less dense than dry air. Thus, on a hot humid day, an aircraft must be flown at a greater true airspeed for any given AOA than on a cool, dry day.

If the density factor is decreased and the total lift must equal the total weight to remain in flight, it follows that one of the other factors must be increased. The factor usually increased is the airspeed or the AOA because these are controlled directly by the pilot.

Lift varies directly with the wing area, provided there is no change in the wing’s planform. If the wings have the same proportion and airfoil sections, a wing with a planform area of 200 square feet lifts twice as much at the same AOA as a wing with an area of 100 square feet.

Two major aerodynamic factors from the pilot’s viewpoint are lift and airspeed because they can be controlled readily and accurately. Of course, the pilot can also control density by adjusting the altitude and can control wing area if the aircraft happens to have flaps of the type that enlarge wing area. However, for most situations, the pilot controls lift and airspeed to maneuver an aircraft. For instance, in straight-and-level flight, cruising along at a constant altitude, altitude is maintained by adjusting lift to match the aircraft’s velocity or cruise airspeed, while maintaining a state of equilibrium in which lift equals weight. In an approach to landing, when the pilot wishes to land as slowly as practical, it is necessary to increase AOA near maximum to maintain lift equal to the weight of the aircraft.

### Lift/Drag Ratio

The lift-to-drag ratio (L/D) is the amount of lift generated by a wing or airfoil compared to its drag. A ratio of L/D indicates airfoil efficiency. Aircraft with higher L/D ratios are more efficient than those with lower L/D ratios. In unaccelerated flight with the lift and drag data steady, the proportions of the coefficient of lift ( $C_L$ ) and coefficient of drag ( $C_D$ ) can be calculated for specific AOA. [Figure 5-5]

The coefficient of lift is dimensionless and relates the lift generated by a lifting body, the dynamic pressure of the fluid

flow around the body, and a reference area associated with the body. The coefficient of drag is also dimensionless and is used to quantify the drag of an object in a fluid environment, such as air, and is always associated with a particular surface area.

The L/D ratio is determined by dividing the  $C_L$  by the  $C_D$ , which is the same as dividing the lift equation by the drag equation as all of the variables, aside from the coefficients, cancel out. The lift and drag equations are as follows (L = Lift in pounds; D = Drag;  $C_L$  = coefficient of lift;  $\rho$  = density (expressed in slugs per cubic feet); V = velocity (in feet per second); q = dynamic pressure per square foot ( $q = \frac{1}{2} \rho v^2$ ); S = the area of the lifting body (in square feet); and  $C_D$  = Ratio of drag pressure to dynamic pressure):

$$D = \frac{C_D \cdot \rho \cdot V^2 \cdot S}{2}$$

Typically at low AOA, the coefficient of drag is low and small changes in AOA create only slight changes in the coefficient of drag. At high AOA, small changes in the AOA cause significant changes in drag. The shape of an airfoil, as well as changes in the AOA, affects the production of lift.

Notice in *Figure 5-5* that the coefficient of lift curve (red) reaches its maximum for this particular wing section at 20° AOA and then rapidly decreases. 20° AOA is therefore the critical angle of attack. The coefficient of drag curve (orange) increases very rapidly from 14° AOA and completely overcomes the lift curve at 21° AOA. The lift/drag ratio (green) reaches its maximum at 6° AOA, meaning that at this angle, the most lift is obtained for the least amount of drag.

Note that the maximum lift/drag ratio ( $L/D_{MAX}$ ) occurs at one specific  $C_L$  and AOA. If the aircraft is operated in steady flight at  $L/D_{MAX}$ , the total drag is at a minimum. Any AOA lower or higher than that for  $L/D_{MAX}$  reduces the L/D and consequently increases the total drag for a given aircraft’s

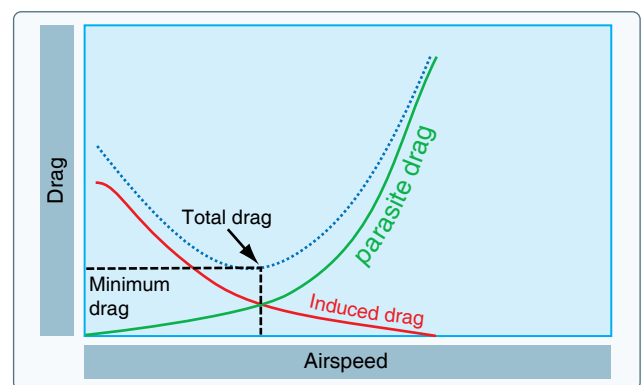

Figure 5-6. Drag versus speed.

lift. *Figure 5-6* depicts the  $L/D_{MAX}$  by the lowest portion of the blue line labeled “total drag.” The configuration of an aircraft has a great effect on the  $L/D$ .

## Drag

Drag is the force that resists movement of an aircraft through the air. There are two basic types: parasite drag and induced drag. The first is called parasite because it in no way functions to aid flight, while the second, induced drag, is a result of an airfoil developing lift.

### Parasite Drag

Parasite drag is comprised of all the forces that work to slow an aircraft’s movement. As the term parasite implies, it is the drag that is not associated with the production of lift. This includes the displacement of the air by the aircraft, turbulence generated in the airstream, or a hindrance of air moving over the surface of the aircraft and airfoil. There are three types of parasite drag: form drag, interference drag, and skin friction.

#### Form Drag

Form drag is the portion of parasite drag generated by the aircraft due to its shape and airflow around it. Examples include the engine cowlings, antennas, and the aerodynamic shape of other components. When the air has to separate to move around a moving aircraft and its components, it eventually rejoins after passing the body. How quickly and smoothly it rejoins is representative of the resistance that it creates, which requires additional force to overcome. [*Figure 5-7*]

Notice how the flat plate in *Figure 5-7* causes the air to swirl around the edges until it eventually rejoins downstream. Form

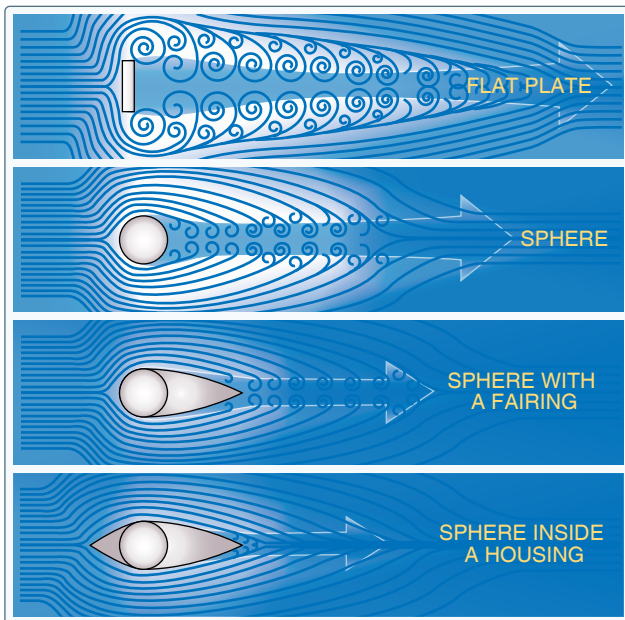

**Figure 5-7.** Form drag.

drag is the easiest to reduce when designing an aircraft. The solution is to streamline as many of the parts as possible.

### Interference Drag

Interference drag comes from the intersection of airstreams that creates eddy currents, turbulence, or restricts smooth airflow. For example, the intersection of the wing and the fuselage at the wing root has significant interference drag. Air flowing around the fuselage collides with air flowing over the wing, merging into a current of air different from the two original currents. The most interference drag is observed when two surfaces meet at perpendicular angles. Fairings are used to reduce this tendency. If a jet fighter carries two identical wing tanks, the overall drag is greater than the sum of the individual tanks because both of these create and generate interference drag. Fairings and distance between lifting surfaces and external components (such as radar antennas hung from wings) reduce interference drag. [*Figure 5-8*]

### Skin Friction Drag

Skin friction drag is the aerodynamic resistance due to the contact of moving air with the surface of an aircraft. Every surface, no matter how apparently smooth, has a rough, ragged surface when viewed under a microscope. The air molecules, which come in direct contact with the surface of the wing, are virtually motionless. Each layer of molecules above the surface moves slightly faster until the molecules are moving at the velocity of the air moving around the aircraft. This speed is called the free-stream velocity. The area between the wing and the free-stream velocity level is about as wide as a playing card and is called the boundary layer. At the top of the boundary layer, the molecules increase velocity and move at the same speed as the molecules outside the boundary layer. The actual speed at which the molecules move depends upon the shape of the wing, the viscosity (stickiness) of the air through which the wing or airfoil is moving, and its compressibility (how much it can be compacted).

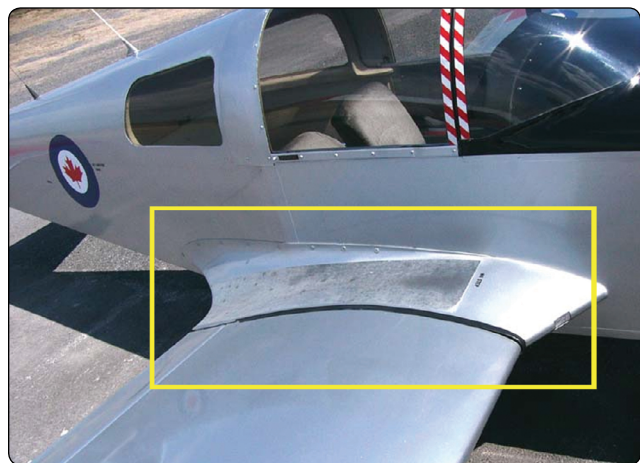

**Figure 5-8.** A wing root can cause interference drag.

The airflow outside of the boundary layer reacts to the shape of the edge of the boundary layer just as it would to the physical surface of an object. The boundary layer gives any object an “effective” shape that is usually slightly different from the physical shape. The boundary layer may also separate from the body, thus creating an effective shape much different from the physical shape of the object. This change in the physical shape of the boundary layer causes a dramatic decrease in lift and an increase in drag. When this happens, the airfoil has stalled.

In order to reduce the effect of skin friction drag, aircraft designers utilize flush mount rivets and remove any irregularities that may protrude above the wing surface. In addition, a smooth and glossy finish aids in transition of air across the surface of the wing. Since dirt on an aircraft disrupts the free flow of air and increases drag, keep the surfaces of an aircraft clean and waxed.

### ***Induced Drag***

The second basic type of drag is induced drag. It is an established physical fact that no system that does work in the mechanical sense can be 100 percent efficient. This means that whatever the nature of the system, the required work is obtained at the expense of certain additional work that is dissipated or lost in the system. The more efficient the system, the smaller this loss.

In level flight, the aerodynamic properties of a wing or rotor produce a required lift, but this can be obtained only at the expense of a certain penalty. The name given to this penalty is induced drag. Induced drag is inherent whenever an airfoil is producing lift and, in fact, this type of drag is inseparable from the production of lift. Consequently, it is always present if lift is produced.

An airfoil (wing or rotor blade) produces the lift force by making use of the energy of the free airstream. Whenever an airfoil is producing lift, the pressure on the lower surface of it is greater than that on the upper surface (Bernoulli’s Principle). As a result, the air tends to flow from the high pressure area below the tip upward to the low pressure area on the upper surface. In the vicinity of the tips, there is a tendency for these pressures to equalize, resulting in a lateral flow outward from the underside to the upper surface. This lateral flow imparts a rotational velocity to the air at the tips, creating vortices that trail behind the airfoil.

When the aircraft is viewed from the tail, these vortices circulate counterclockwise about the right tip and clockwise about the left tip. [Figure 5-9] As the air (and vortices) roll off the back of your wing, they angle down, which is known as downwash. Figure 5-10 shows the difference in downwash at



**Figure 5-9.** Wingtip vortex from a crop duster.

altitude versus near the ground. Bearing in mind the direction of rotation of these vortices, it can be seen that they induce an upward flow of air beyond the tip and a downwash flow behind the wing’s trailing edge. This induced downwash has nothing in common with the downwash that is necessary to produce lift. It is, in fact, the source of induced drag.

Downwash points the relative wind downward, so the more downwash you have, the more your relative wind points downward. That’s important for one very good reason: lift is always perpendicular to the relative wind. In Figure 5-11, you can see that when you have less downwash, your lift vector is more vertical, opposing gravity. And when you have more downwash, your lift vector points back more, causing induced drag. On top of that, it takes energy for your wings to create downwash and vortices, and that energy creates drag.

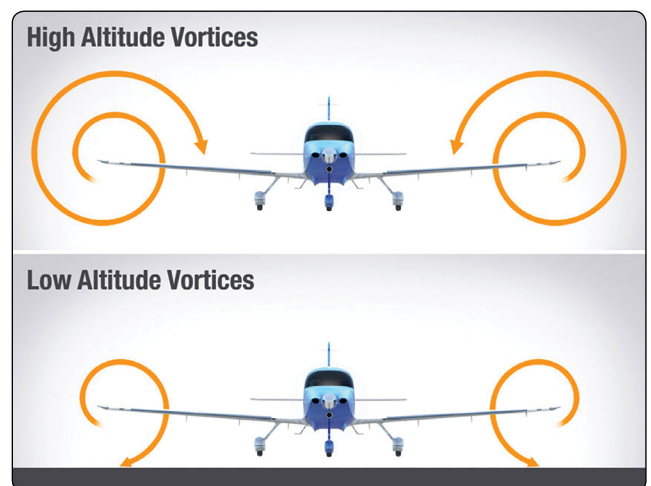

**Figure 5-10.** The difference in wingtip vortex size at altitude versus near the ground.

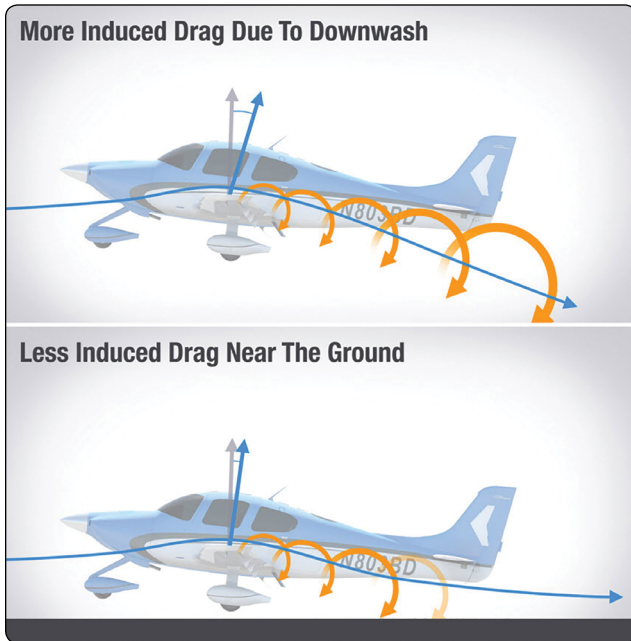

**Figure 5-11.** The difference in downwash at altitude versus near the ground.

The greater the size and strength of the vortices and consequent downwash component on the net airflow over the airfoil, the greater the induced drag effect becomes. This downwash over the top of the airfoil at the tip has the same effect as bending the lift vector rearward; therefore, the lift is slightly aft of perpendicular to the relative wind, creating a rearward lift component. This is induced drag.

In order to create a greater negative pressure on the top of an airfoil, the airfoil can be inclined to a higher AOA. If the AOA of a symmetrical airfoil were zero, there would be no pressure differential, and consequently, no downwash component and no induced drag. In any case, as AOA increases, induced drag increases proportionally. To state this another way—the lower the airspeed, the greater the AOA required to produce lift equal to the aircraft’s weight and, therefore, the greater induced drag. The amount of induced drag varies inversely with the square of the airspeed.

Conversely, parasite drag increases as the square of the airspeed. Thus, in steady state, as airspeed decreases to near the stalling speed, the total drag becomes greater, due mainly to the sharp rise in induced drag. Similarly, as the aircraft reaches its never-exceed speed ( $V_{NE}$ ), the total drag increases rapidly due to the sharp increase of parasite drag. As seen in *Figure 5-6*, at some given airspeed, total drag is at its minimum amount. In figuring the maximum range of aircraft, the thrust required to overcome drag is at a minimum if drag is at a minimum. The minimum power and maximum endurance occur at a different point.

## Weight

Gravity is the pulling force that tends to draw all bodies to the center of the earth. The CG may be considered as a point at which all the weight of the aircraft is concentrated. If the aircraft were supported at its exact CG, it would balance in any attitude. It will be noted that CG is of major importance in an aircraft, for its position has a great bearing upon stability. The allowable location of the CG is determined by the general design of each particular aircraft. The designers determine how far the center of pressure (CP) will travel. It is important to understand that an aircraft’s weight is concentrated at the CG and the aerodynamic forces of lift occur at the CP. When the CG is forward of the CP, there is a natural tendency for the aircraft to want to pitch nose down. If the CP is forward of the CG, a nose up pitching moment is created. Therefore, designers fix the aft limit of the CG forward of the CP for the corresponding flight speed in order to retain flight equilibrium.

Weight has a definite relationship to lift. This relationship is simple, but important in understanding the aerodynamics of flying. Lift is the upward force on the wing acting perpendicular to the relative wind and perpendicular to the aircraft’s lateral axis. Lift is required to counteract the aircraft’s weight. In stabilized level flight, when the lift force is equal to the weight force, the aircraft is in a state of equilibrium and neither accelerates upward or downward. If lift becomes less than weight, the vertical speed will decrease. When lift is greater than weight, the vertical speed will increase.

## Wingtip Vortices

### Formation of Vortices

The action of the airfoil that gives an aircraft lift also causes induced drag. When an airfoil is flown at a positive AOA, a pressure differential exists between the upper and lower surfaces of the airfoil. The pressure above the wing is less than atmospheric pressure and the pressure below the wing is equal to or greater than atmospheric pressure. Since air always moves from high pressure toward low pressure, and the path of least resistance is toward the airfoil’s tips, there is a spanwise movement of air from the bottom of the airfoil outward from the fuselage around the tips. This flow of air results in “spillage” over the tips, thereby setting up a whirlpool of air called a vortex. [*Figure 5-12*]

At the same time, the air on the upper surface has a tendency to flow in toward the fuselage and off the trailing edge. This air current forms a similar vortex at the inboard portion of the trailing edge of the airfoil, but because the fuselage limits the inward flow, the vortex is insignificant. Consequently, the deviation in flow direction is greatest at the outer tips where the unrestricted lateral flow is the strongest.



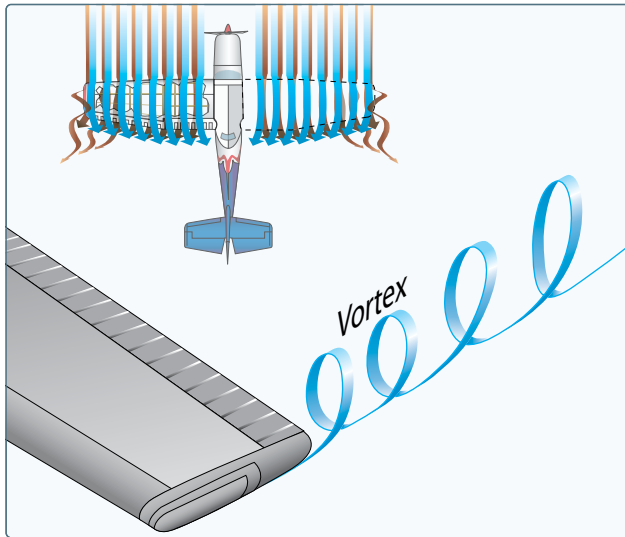

**Figure 5-12.** Wingtip vortices.

As the air curls upward around the tip, it combines with the downwash to form a fast-spinning trailing vortex. These vortices increase drag because of energy spent in producing the turbulence. Whenever an airfoil is producing lift, induced drag occurs and wingtip vortices are created.

Just as lift increases with an increase in AOA, induced drag also increases. This occurs because as the AOA is increased, there is a greater pressure difference between the top and bottom of the airfoil, and a greater lateral flow of air; consequently, this causes more violent vortices to be set up, resulting in more turbulence and more induced drag.

In *Figure 5-12*, it is easy to see the formation of wingtip vortices. The intensity or strength of the vortices is directly proportional to the weight of the aircraft and inversely proportional to the wingspan and speed of the aircraft. The heavier and slower the aircraft, the greater the AOA and the stronger the wingtip vortices. Thus, an aircraft will create wingtip vortices with maximum strength occurring during the takeoff, climb, and landing phases of flight. These

vortices lead to a particularly dangerous hazard to flight, wake turbulence.

### Avoiding Wake Turbulence

Wingtip vortices are greatest when the generating aircraft is “heavy, clean, and slow.” This condition is most commonly encountered during approaches or departures because an aircraft’s AOA is at the highest to produce the lift necessary to land or take off. To minimize the chances of flying through an aircraft’s wake turbulence:

- Avoid flying through another aircraft’s flight path.
- Rotate prior to the point at which the preceding aircraft rotated when taking off behind another aircraft.
- Avoid following another aircraft on a similar flight path at an altitude within 1,000 feet. [*Figure 5-13*]
- Approach the runway above a preceding aircraft’s path when landing behind another aircraft and touch down after the point at which the other aircraft wheels contacted the runway. [*Figure 5-14*]

A hovering helicopter generates a down wash from its main rotor(s) similar to the vortices of an airplane. Pilots of small aircraft should avoid a hovering helicopter by at least three rotor disc diameters to avoid the effects of this down wash. In forward flight, this energy is transformed into a pair of strong, high-speed trailing vortices similar to wing-tip vortices of larger fixed-wing aircraft. Helicopter vortices should be avoided because helicopter forward flight airspeeds are often very slow and can generate exceptionally strong wake turbulence.

Wind is an important factor in avoiding wake turbulence because wingtip vortices drift with the wind at the speed of the wind. For example, a wind speed of 10 knots causes the vortices to drift at about 1,000 feet in a minute in the wind direction. When following another aircraft, a pilot should consider wind speed and direction when selecting an intended takeoff or landing point. If a pilot is unsure of the other aircraft’s takeoff or landing point, approximately 3 minutes provides a margin of

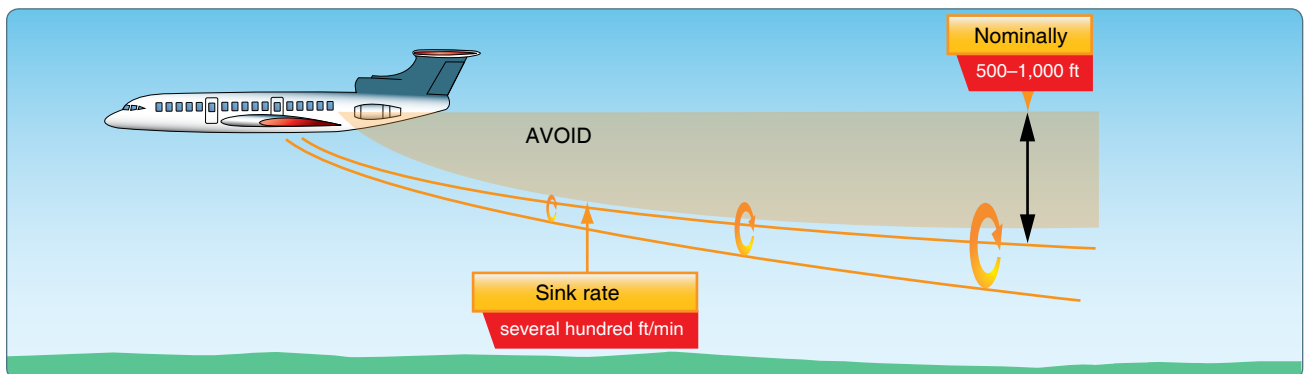

**Figure 5-13.** Avoid following another aircraft at an altitude within 1,000 feet.

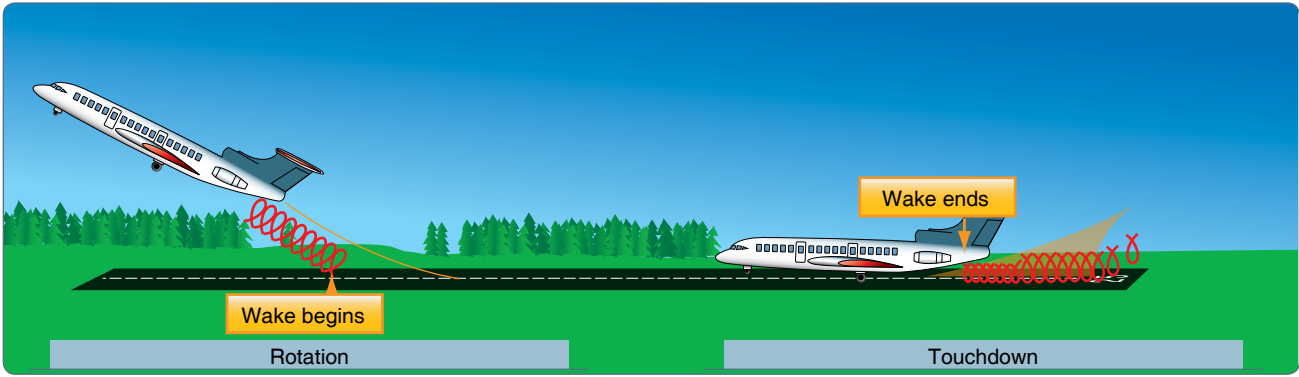

Figure 5-14. Avoid turbulence from another aircraft.

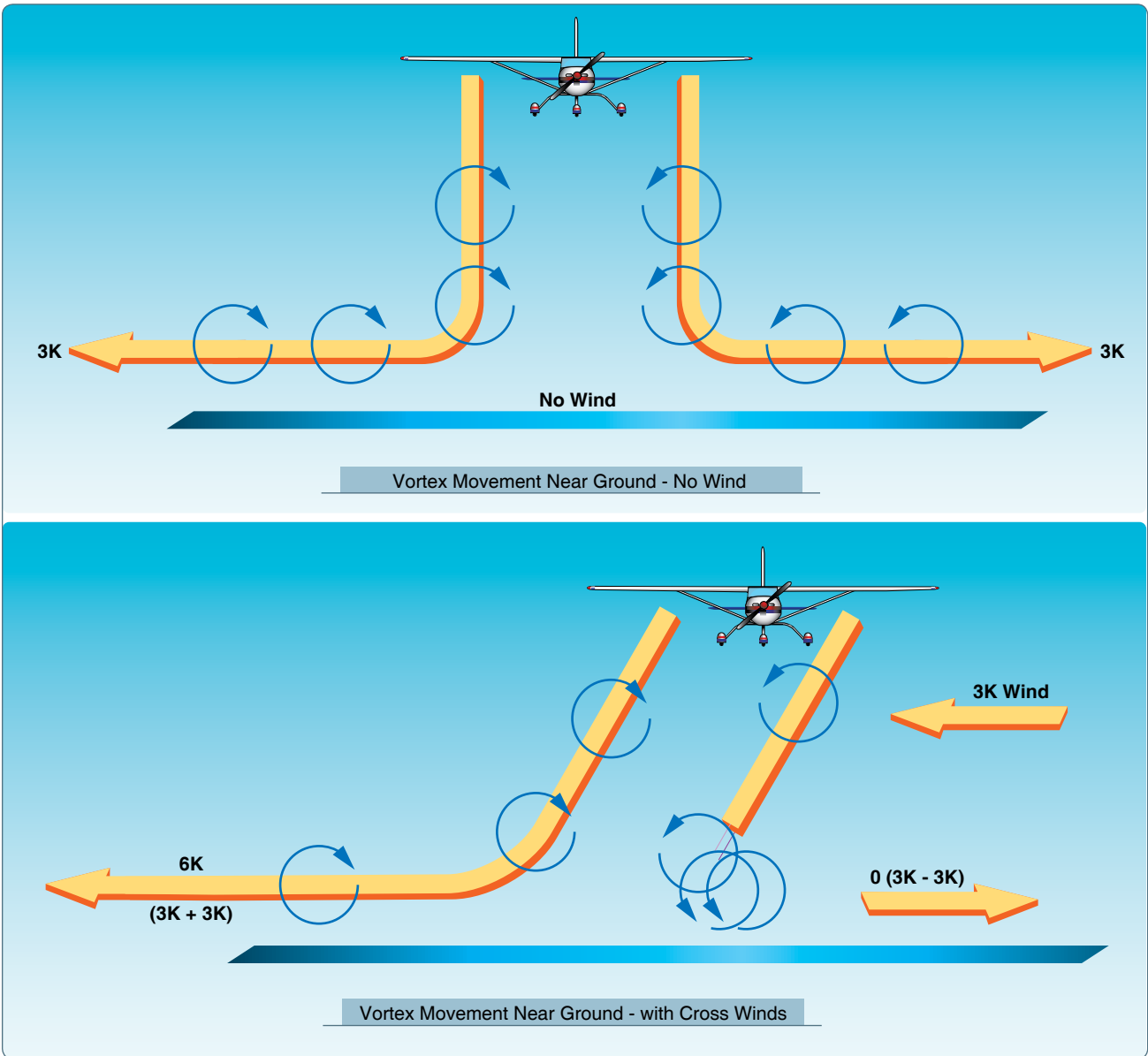

Figure 5-15. When the vortices of larger aircraft sink close to the ground (within 100 to 200 feet), they tend to move laterally over the ground at a speed of 2 or 3 knots (top). A crosswind will decrease the lateral movement of the upwind vortex and increase the movement of the downwind vortex. Thus a light wind with a cross runway component of 1 to 5 knots could result in the upwind vortex remaining in the touchdown zone for a period of time and hasten the drift of the downwind vortex toward another runway (bottom).

safety that allows wake turbulence dissipation. [Figure 5-15] For more information on wake turbulence, see Advisory Circular (AC) 90-23, Aircraft Wake Turbulence.

## Ground Effect

Ever since the beginning of manned flight, pilots realized that just before touchdown it would suddenly feel like the aircraft did not want to go lower, and it would just want to go on and on. This is due to the air that is trapped between the wing and the landing surface, as if there were an air cushion. This phenomenon is called ground effect.

When an aircraft in flight comes within several feet of the surface, ground or water, a change occurs in the three-dimensional flow pattern around the aircraft because the vertical component of the airflow around the wing is restricted by the surface. This alters the wing's upwash, downwash, and wingtip vortices. [Figure 5-16] Ground effect, then, is due to the interference of the ground (or water) surface with the airflow patterns about the aircraft in flight. While the aerodynamic characteristics of the tail surfaces and the fuselage are altered by ground effect, the principal effects due to proximity of the ground are the changes in the aerodynamic characteristics of the wing. As the wing encounters ground effect and is maintained at a constant AOA, there is consequent reduction in the upwash, downwash, and wingtip vortices.

Induced drag is a result of the airfoil's work of sustaining the aircraft, and a wing or rotor lifts the aircraft simply by accelerating a mass of air downward. It is true that reduced pressure on top of an airfoil is essential to lift, but that is only one of the things contributing to the overall effect of pushing an air mass downward. The more downwash there is, the harder the wing pushes the mass of air down. At high angles of attack, the amount of induced drag is high; since this corresponds to lower airspeeds in actual flight, it can be said that induced drag predominates at low speed. However, the reduction of the wingtip vortices due to ground effect alters

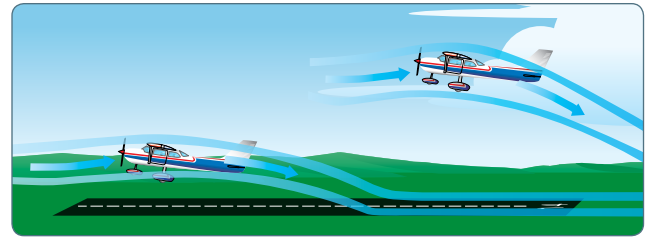

Figure 5-16. Ground effect changes airflow.

the spanwise lift distribution and reduces the induced AOA and induced drag. Therefore, the wing will require a lower AOA in ground effect to produce the same  $C_L$ . If a constant AOA is maintained, an increase in  $C_L$  results. [Figure 5-17]

Ground effect also alters the thrust required versus velocity. Since induced drag predominates at low speeds, the reduction of induced drag due to ground effect will cause a significant reduction of thrust required (parasite plus induced drag) at low speeds. Due to the change in upwash, downwash, and wingtip vortices, there may be a change in position (installation) error of the airspeed system associated with ground effect. In the majority of cases, ground effect causes an increase in the local pressure at the static source and produces a lower indication of airspeed and altitude. Thus, an aircraft may be airborne at an indicated airspeed less than that normally required.

In order for ground effect to be of significant magnitude, the wing must be quite close to the ground. One of the direct results of ground effect is the variation of induced drag with wing height above the ground at a constant  $C_L$ . When the wing is at a height equal to its span, the reduction in induced drag is only 1.4 percent. However, when the wing is at a height equal to one-fourth its span, the reduction in induced drag is 23.5 percent and, when the wing is at a height equal to one-tenth its span, the reduction in induced drag is 47.6 percent. Thus, a large reduction in induced drag takes place only when the wing is very close to the ground. Because of this variation, ground effect is most usually recognized during the liftoff for takeoff or just prior to touchdown when landing.

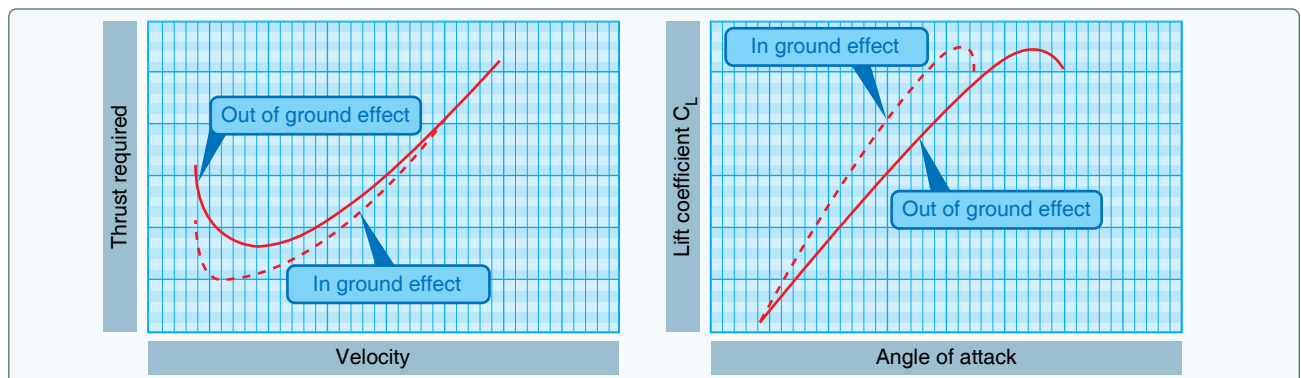

Figure 5-17. Ground effect changes drag and lift.

During the takeoff phase of flight, ground effect produces some important relationships. An aircraft leaving ground effect after takeoff encounters just the reverse of an aircraft entering ground effect during landing. The aircraft leaving ground effect will:

- Require an increase in AOA to maintain the same  $C_L$
- Experience an increase in induced drag and thrust required
- Experience a decrease in stability and a nose-up change in moment
- Experience a reduction in static source pressure and increase in indicated airspeed

Ground effect must be considered during takeoffs and landings. For example, if a pilot fails to understand the relationship between the aircraft and ground effect during takeoff, a hazardous situation is possible because the recommended takeoff speed may not be achieved. Due to the reduced drag in ground effect, the aircraft may seem capable of takeoff well below the recommended speed. As the aircraft rises out of ground effect with a deficiency of speed, the greater induced drag may result in marginal initial climb performance. In extreme conditions, such as high gross weight, high density altitude, and high temperature, a deficiency of airspeed during takeoff may permit the aircraft to become airborne but be incapable of sustaining flight out of ground effect. In this case, the aircraft may become airborne initially with a deficiency of speed and then settle back to the runway.

A pilot should not attempt to force an aircraft to become airborne with a deficiency of speed. The manufacturer's recommended takeoff speed is necessary to provide adequate initial climb performance. It is also important that a definite climb be established before a pilot retracts the landing gear or flaps. Never retract the landing gear or flaps prior to

establishing a positive rate of climb and only after achieving a safe altitude.

If, during the landing phase of flight, the aircraft is brought into ground effect with a constant AOA, the aircraft experiences an increase in  $C_L$  and a reduction in the thrust required, and a "floating" effect may occur. Because of the reduced drag and lack of power-off deceleration in ground effect, any excess speed at the point of flare may incur a considerable "float" distance. As the aircraft nears the point of touchdown, ground effect is most realized at altitudes less than the wingspan. During the final phases of the approach as the aircraft nears the ground, a reduction of power is necessary to offset the increase in lift caused from ground effect otherwise the aircraft will have a tendency to climb above the desired glidepath (GP).

### Axes of an Aircraft

The axes of an aircraft are three imaginary lines that pass through an aircraft's CG. The axes can be considered as imaginary axles around which the aircraft turns. The three axes pass through the CG at 90° angles to each other. The axis that passes through the CG and parallel to a line from nose to tail is the longitudinal axis, the axis that passes parallel to a line from wingtip to wingtip is the lateral axis, and the axis that passes through the CG at right angles to the other two axes is the vertical axis. Whenever an aircraft changes its flight attitude or position in flight, it rotates about one or more of the three axes. [Figure 5-18]

The aircraft's motion about its longitudinal axis resembles the roll of a ship from side to side. In fact, the names used to describe the motion about an aircraft's three axes were originally nautical terms. They have been adapted to aeronautical terminology due to the similarity of motion of aircraft and seagoing ships. The motion about the aircraft's longitudinal axis is "roll," the motion about its lateral axis is

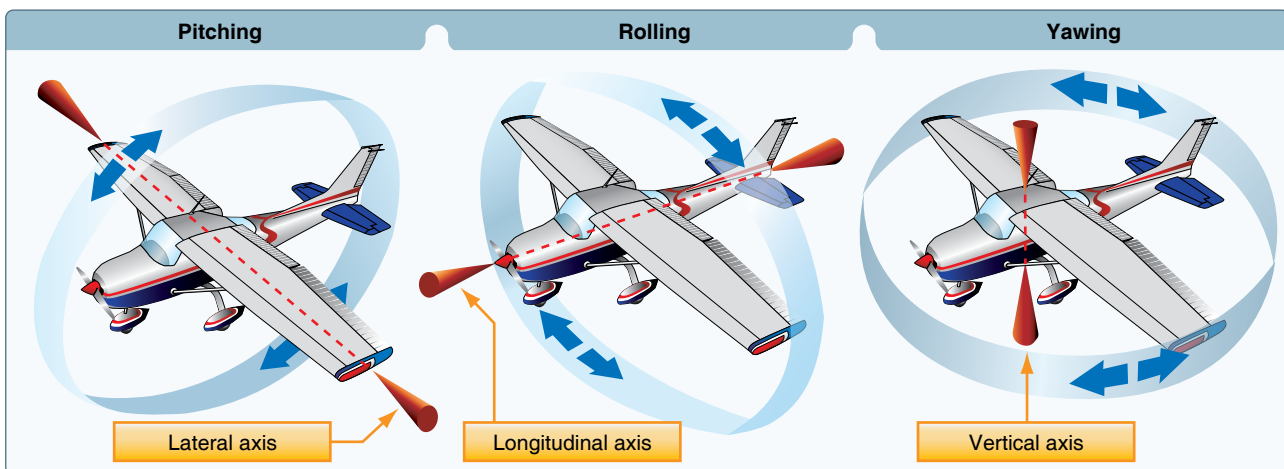

Figure 5-18. Axes of an airplane.

“pitch,” and the motion about its vertical axis is “yaw.” Yaw is the left and right movement of the aircraft’s nose.

The three motions of the conventional airplane (roll, pitch, and yaw) are controlled by three control surfaces. Roll is controlled by the ailerons; pitch is controlled by the elevators; yaw is controlled by the rudder. The use of these controls is explained in Chapter 6, Flight Controls. Other types of aircraft may utilize different methods of controlling the movements about the various axes.

For example, weight-shift control aircraft control two axes (roll and pitch) using an “A” frame suspended from the flexible wing attached to a three-wheeled carriage. These aircraft are controlled by moving a horizontal bar (called a control bar) in roughly the same way hang glider pilots fly. [Figure 5-19] They are termed weight-shift control aircraft because the pilot controls the aircraft by shifting the CG. For more information on weight-shift control aircraft, see the Federal Aviation Administration (FAA) Weight-Shift Control Flying Handbook, FAA-H-8083-5. In the case of powered parachutes, aircraft control is accomplished by altering the airfoil via steering lines.

A powered parachute wing is a parachute that has a cambered upper surface and a flatter under surface. The two surfaces are separated by ribs that act as cells, which open to the airflow at the leading edge and have internal ports to allow lateral airflow. The principle at work holds that the cell pressure is greater than the outside pressure, thereby forming a wing that maintains its airfoil shape in flight. The pilot and passenger sit in tandem in front of the engine, which is located at the rear of a vehicle. The airframe is attached to the parachute via two attachment points and lines. Control is accomplished by both power and the changing of the airfoil via the control lines. [Figure 5-20]



Figure 5-19. A weight-shift control aircraft.



Figure 5-20. A powered parachute.

## Moment and Moment Arm

A study of physics shows that a body that is free to rotate will always turn about its CG. In aerodynamic terms, the mathematical measure of an aircraft’s tendency to rotate about its CG is called a “moment.” A moment is said to be equal to the product of the force applied and the distance at which the force is applied. (A moment arm is the distance from a datum [reference point or line] to the applied force.) For aircraft weight and balance computations, “moments” are expressed in terms of the distance of the arm times the aircraft’s weight, or simply, inch-pounds.

Aircraft designers locate the fore and aft position of the aircraft’s CG as nearly as possible to the 20 percent point of the mean aerodynamic chord (MAC). If the thrust line is designed to pass horizontally through the CG, it will not cause the aircraft to pitch when power is changed, and there will be no difference in moment due to thrust for a power-on or power-off condition of flight. Although designers have some control over the location of the drag forces, they are not always able to make the resultant drag forces pass through the CG of the aircraft. However, the one item over which they have the greatest control is the size and location of the tail. The objective is to make the moments (due to thrust, drag, and lift) as small as possible and, by proper location of the tail, to provide the means of balancing an aircraft longitudinally for any condition of flight.

The pilot has no direct control over the location of forces acting on the aircraft in flight, except for controlling the center of lift by changing the AOA. The pilot can control the magnitude of the forces. Such a change, however, immediately involves changes in other forces. Therefore, the pilot cannot independently change the location of one force without changing the effect of others. For example, a change in airspeed involves a change in lift, as well as a change in drag and a change in the up or down force on the

tail. As forces such as turbulence and gusts act to displace the aircraft, the pilot reacts by providing opposing control forces to counteract this displacement.

Some aircraft are subject to changes in the location of the CG with variations of load. Trimming devices, such as elevator trim tabs and adjustable horizontal stabilizers, are used to counteract the moments set up by fuel burnoff and loading or off-loading of passengers or cargo.

## Aircraft Design Characteristics

Each aircraft handles somewhat differently because each resists or responds to control pressures in its own way. For example, a training aircraft is quick to respond to control applications, while a transport aircraft feels heavy on the controls and responds to control pressures more slowly. These features can be designed into an aircraft to facilitate the particular purpose of the aircraft by considering certain stability and maneuvering requirements. The following discussion summarizes the more important aspects of an aircraft's stability, maneuverability, and controllability qualities; how they are analyzed; and their relationship to various flight conditions.

### Stability

Stability is the inherent quality of an aircraft to correct for conditions that may disturb its equilibrium and to return to or to continue on the original flight path. It is primarily an aircraft design characteristic. The flight paths and attitudes an aircraft flies are limited by the aerodynamic characteristics of the aircraft, its propulsion system, and its structural strength. These limitations indicate the maximum performance and

maneuverability of the aircraft. If the aircraft is to provide maximum utility, it must be safely controllable to the full extent of these limits without exceeding the pilot's strength or requiring exceptional flying ability. If an aircraft is to fly straight and steady along any arbitrary flight path, the forces acting on it must be in static equilibrium. The reaction of any body when its equilibrium is disturbed is referred to as stability. The two types of stability are static and dynamic.

### Static Stability

Static stability refers to the initial tendency, or direction of movement, back to equilibrium. In aviation, it refers to the aircraft's initial response when disturbed from a given pitch, yaw, or bank.

- Positive static stability—the initial tendency of the aircraft to return to the original state of equilibrium after being disturbed. [Figure 5-21]
- Neutral static stability—the initial tendency of the aircraft to remain in a new condition after its equilibrium has been disturbed. [Figure 5-21]
- Negative static stability—the initial tendency of the aircraft to continue away from the original state of equilibrium after being disturbed. [Figure 5-21]

### Dynamic Stability

Static stability has been defined as the initial tendency to return to equilibrium that the aircraft displays after being disturbed from its trimmed condition. Occasionally, the initial tendency is different or opposite from the overall tendency, so a distinction must be made between the two. Dynamic stability refers to the aircraft response over time

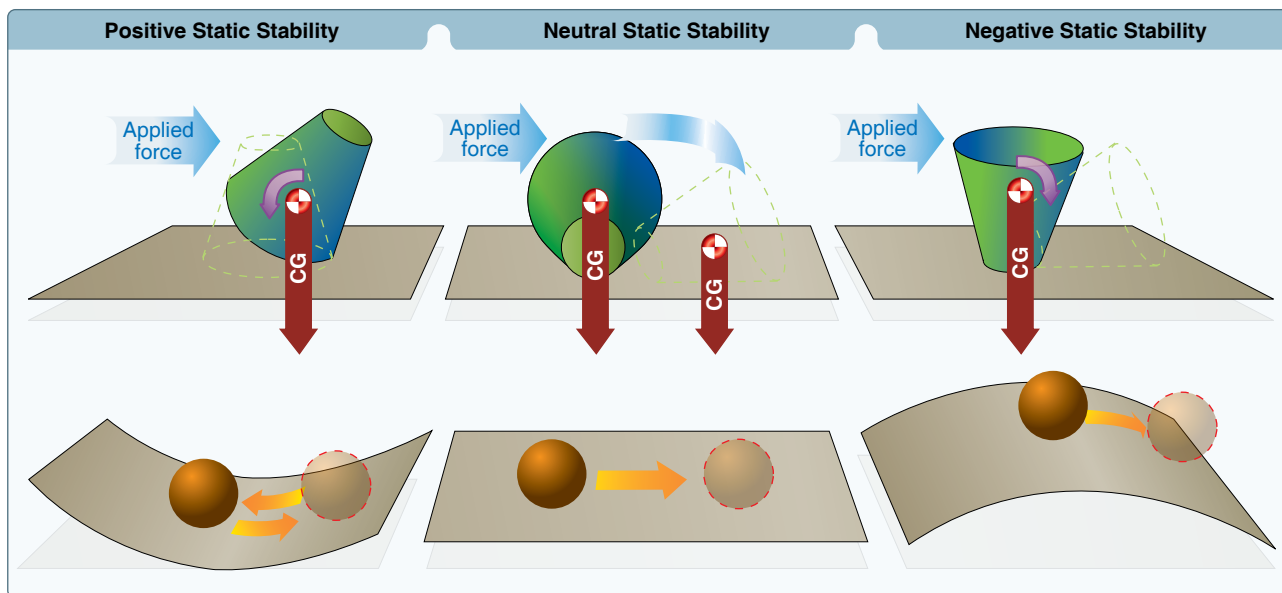

Figure 5-21. Types of static stability.

when disturbed from a given pitch, yaw, or bank. This type of stability also has three subtypes: [Figure 5-22]

- Positive dynamic stability—over time, the motion of the displaced object decreases in amplitude and, because it is positive, the object displaced returns toward the equilibrium state.
- Neutral dynamic stability—once displaced, the displaced object neither decreases nor increases in amplitude. A worn automobile shock absorber exhibits this tendency.
- Negative dynamic stability—over time, the motion of the displaced object increases and becomes more divergent.

Stability in an aircraft affects two areas significantly:

- Maneuverability—the quality of an aircraft that permits it to be maneuvered easily and to withstand the stresses imposed by maneuvers. It is governed by the aircraft’s weight, inertia, size and location of flight controls, structural strength, and powerplant. It too is an aircraft design characteristic.
- Controllability—the capability of an aircraft to respond to the pilot’s control, especially with regard to flight path and attitude. It is the quality of the aircraft’s response to the pilot’s control application when maneuvering the aircraft, regardless of its stability characteristics.

**Longitudinal Stability (Pitching)**

In designing an aircraft, a great deal of effort is spent in developing the desired degree of stability around all three axes. But longitudinal stability about the lateral axis is

considered to be the most affected by certain variables in various flight conditions.

Longitudinal stability is the quality that makes an aircraft stable about its lateral axis. It involves the pitching motion as the aircraft’s nose moves up and down in flight. A longitudinally unstable aircraft has a tendency to dive or climb progressively into a very steep dive or climb, or even a stall. Thus, an aircraft with longitudinal instability becomes difficult and sometimes dangerous to fly.

Static longitudinal stability, or instability in an aircraft, is dependent upon three factors:

1. Location of the wing with respect to the CG
2. Location of the horizontal tail surfaces with respect to the CG
3. Area or size of the tail surfaces

In analyzing stability, it should be recalled that a body free to rotate always turns about its CG.

To obtain static longitudinal stability, the relation of the wing and tail moments must be such that, if the moments are initially balanced and the aircraft is suddenly nose up, the wing moments and tail moments change so that the sum of their forces provides an unbalanced but restoring moment which, in turn, brings the nose down again. Similarly, if the aircraft is nose down, the resulting change in moments brings the nose back up.

The Center of Lift (CL) in most asymmetrical airfoils has a tendency to change its fore and aft positions with a change in the AOA. The CL tends to move forward with an increase in AOA and to move aft with a decrease in AOA. This means

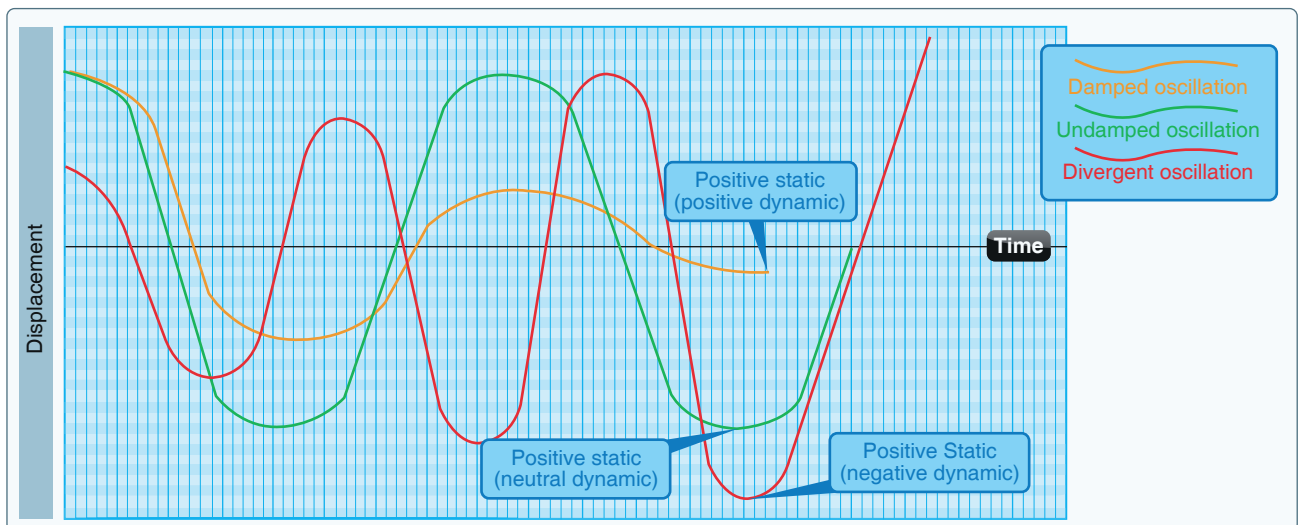

Figure 5-22. Damped versus undamped stability.

that when the AOA of an airfoil is increased, the CL, by moving forward, tends to lift the leading edge of the wing still more. This tendency gives the wing an inherent quality of instability. (NOTE: CL is also known as the center of pressure (CP).)

Figure 5-23 shows an aircraft in straight-and-level flight. The line CG-CL-T represents the aircraft's longitudinal axis from the CG to a point T on the horizontal stabilizer.

Most aircraft are designed so that the wing's CL is to the rear of the CG. This makes the aircraft "nose heavy" and requires that there be a slight downward force on the horizontal stabilizer in order to balance the aircraft and keep the nose from continually pitching downward. Compensation for this nose heaviness is provided by setting the horizontal stabilizer at a slight negative AOA. The downward force thus produced holds the tail down, counterbalancing the "heavy" nose. It is as if the line CG-CL-T were a lever with an upward force at CL and two downward forces balancing each other, one a strong force at the CG point and the other, a much lesser force, at point T (downward air pressure on the stabilizer). To better visualize this physics principle: If an iron bar were suspended at point CL, with a heavy weight hanging on it at the CG, it would take downward pressure at point T to keep the "lever" in balance.

Even though the horizontal stabilizer may be level when the aircraft is in level flight, there is a downwash of air from the wings. This downwash strikes the top of the stabilizer and produces a downward pressure, which at a certain speed is just enough to balance the "lever." The faster the aircraft is flying, the greater this downwash and the greater the downward force on the horizontal stabilizer (except T-tails). [Figure 5-24] In aircraft with fixed-position horizontal stabilizers, the aircraft manufacturer sets the stabilizer at an angle that provides the best stability (or balance) during flight at the design cruising speed and power setting.

If the aircraft's speed decreases, the speed of the airflow over the wing is decreased. As a result of this decreased

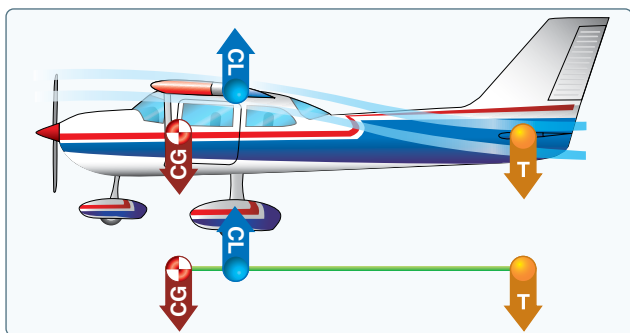

Figure 5-23. Longitudinal stability.

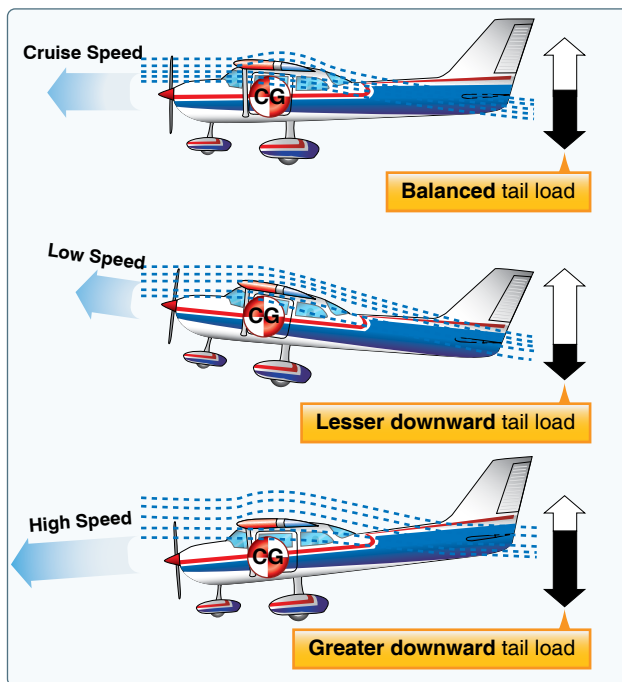

Figure 5-24. Effect of speed on downwash.

flow of air over the wing, the downwash is reduced, causing a lesser downward force on the horizontal stabilizer. In turn, the characteristic nose heaviness is accentuated, causing the aircraft's nose to pitch down more. [Figure 5-25] This places the aircraft in a nose-low attitude, lessening the wing's AOA and drag and allowing the airspeed to increase. As the aircraft continues in the nose-low attitude and its speed increases, the downward force on the horizontal stabilizer is once again increased. Consequently, the tail is again pushed downward and the nose rises into a climbing attitude.

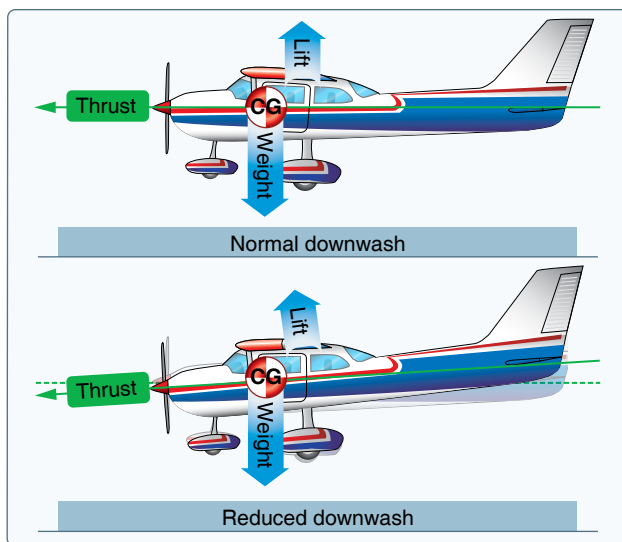

Figure 5-25. Reduced power allows pitch down.



As this climb continues, the airspeed again decreases, causing the downward force on the tail to decrease until the nose lowers once more. Because the aircraft is dynamically stable, the nose does not lower as far this time as it did before. The aircraft acquires enough speed in this more gradual dive to start it into another climb, but the climb is not as steep as the preceding one.

After several of these diminishing oscillations, in which the nose alternately rises and lowers, the aircraft finally settles down to a speed at which the downward force on the tail exactly counteracts the tendency of the aircraft to dive. When this condition is attained, the aircraft is once again in balanced flight and continues in stabilized flight as long as this attitude and airspeed are not changed.

A similar effect is noted upon closing the throttle. The downwash of the wings is reduced and the force at T in *Figure 5-23* is not enough to hold the horizontal stabilizer down. It seems as if the force at T on the lever were allowing the force of gravity to pull the nose down. This is a desirable characteristic because the aircraft is inherently trying to regain airspeed and reestablish the proper balance.

Power or thrust can also have a destabilizing effect in that an increase of power may tend to make the nose rise. The aircraft designer can offset this by establishing a “high thrust line” wherein the line of thrust passes above the CG. [*Figures 5-26 and 5-27*] In this case, as power or thrust is

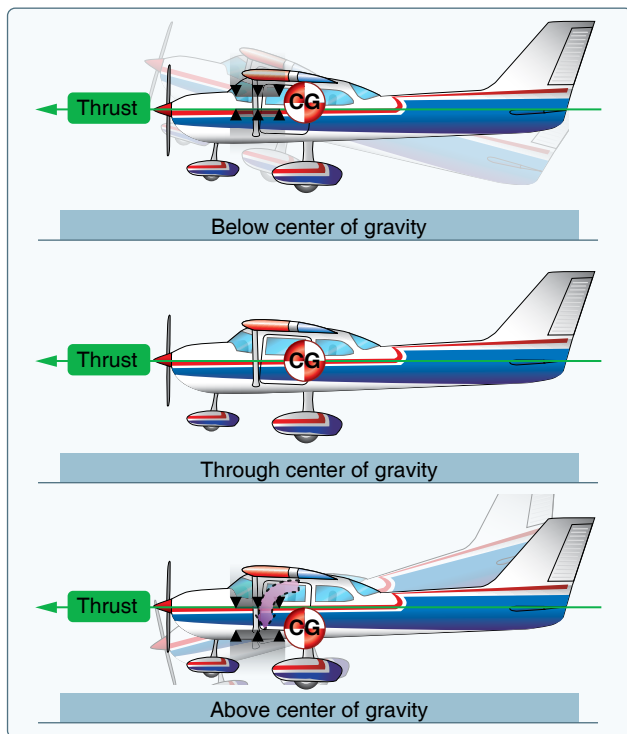

**Figure 5-26.** Thrust line affects longitudinal stability.

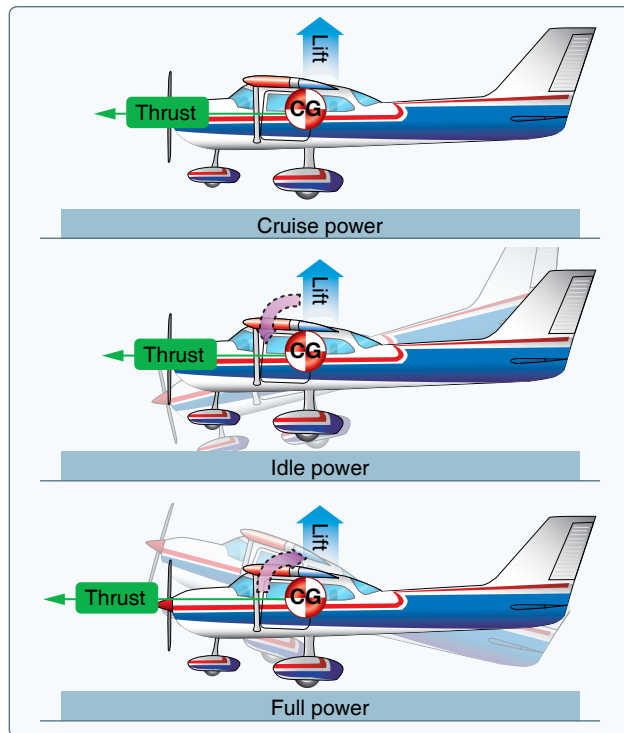

**Figure 5-27.** Power changes affect longitudinal stability.

increased a moment is produced to counteract the down load on the tail. On the other hand, a very “low thrust line” would tend to add to the nose-up effect of the horizontal tail surface. Conclusion: with CG forward of the CL and with an aerodynamic tail-down force, the aircraft usually tries to return to a safe flying attitude.

The following is a simple demonstration of longitudinal stability. Trim the aircraft for “hands off” control in level flight. Then, momentarily give the controls a slight push to nose the aircraft down. If, within a brief period, the nose rises towards the original position, the aircraft is statically stable. Ordinarily, the nose passes the original position (that of level flight) and a series of slow pitching oscillations follows. If the oscillations gradually cease, the aircraft has positive stability; if they continue unevenly, the aircraft has neutral stability; if they increase, the aircraft is unstable.

### ***Lateral Stability (Rolling)***

Stability about the aircraft’s longitudinal axis, which extends from the nose of the aircraft to its tail, is called lateral stability. Positive lateral stability helps to stabilize the lateral or “rolling effect” when one wing gets lower than the wing on the opposite side of the aircraft. There are four main design factors that make an aircraft laterally stable: dihedral, sweepback, keel effect, and weight distribution.

### Dihedral

Some aircraft are designed so that the outer tips of the wings are higher than the wing roots. The upward angle thus formed by the wings is called dihedral. [Figure 5-28] When a gust causes a roll, a sideslip will result. This sideslip causes the relative wind affecting the entire airplane to be from the direction of the slip. When the relative wind comes from the side, the wing slipping into the wind is subject to an increase in AOA and develops an increase in lift. The wing away from the wind is subject to a decrease in angle of attack, and develops a decrease in lift. The changes in lift effect a rolling moment tending to raise the windward wing, hence dihedral contributes to a stable roll due to sideslip. [Figure 5-29]

### Sweepback and Wing Location

Many aspects of an aircraft's configuration can affect its effective dihedral, but two major components are wing sweepback and the wing location with respect to the fuselage (such as a low wing or high wing). As a rough estimation, 10° of sweepback on a wing provides about 1° of effective dihedral, while a high wing configuration can provide about 5° of effective dihedral over a low wing configuration.

A sweptback wing is one in which the leading edge slopes backward. [Figure 5-30] When a disturbance causes an aircraft with sweepback to slip or drop a wing, the low wing presents its leading edge at an angle that is more perpendicular to the relative airflow. As a result, the low wing acquires more lift, rises, and the aircraft is restored to its original flight attitude.

### Keel Effect and Weight Distribution

A high wing aircraft always has the tendency to turn the longitudinal axis of the aircraft into the relative wind, which is often referred to as the keel effect. These aircraft are laterally stable simply because the wings are attached in a high position on the fuselage, making the fuselage behave like a keel exerting a steadying influence on the aircraft laterally about the longitudinal axis. When a high-winged aircraft is

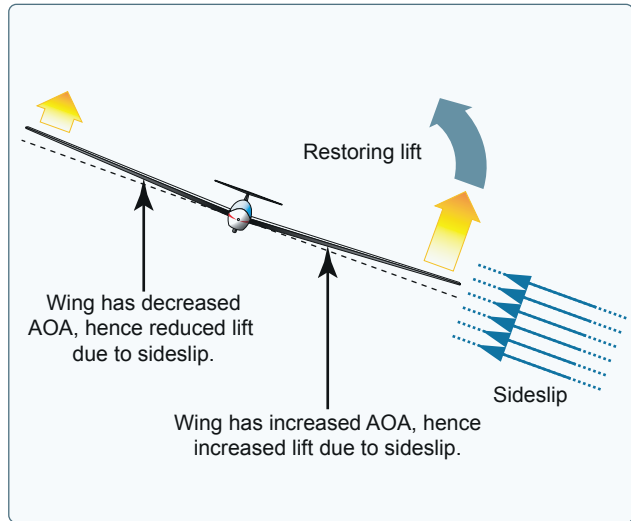

Figure 5-29. Sideslip causing different AOA on each blade.

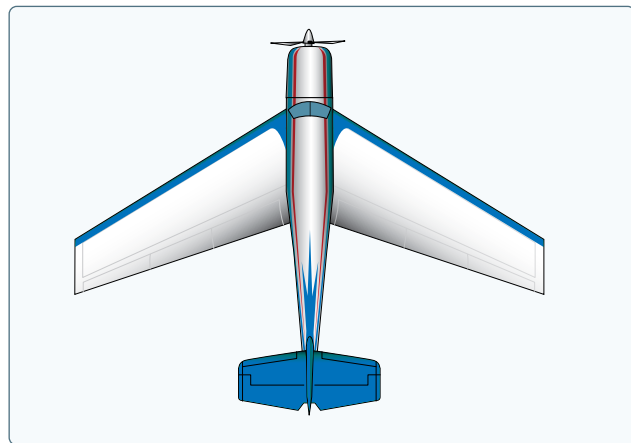

Figure 5-30. Sweepback wings.

disturbed and one wing dips, the fuselage weight acts like a pendulum returning the aircraft to the horizontal level.

Laterally stable aircraft are constructed so that the greater portion of the keel area is above the CG. [Figure 5-31] Thus, when the aircraft slips to one side, the combination of the

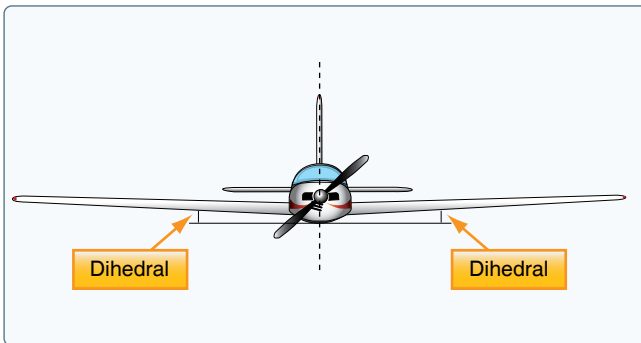

Figure 5-28. Dihedral is the upward angle of the wings from a horizontal (front/rear view) axis of the plane as shown in the graphic depiction and the rear view of a Ryanair Boeing 737.

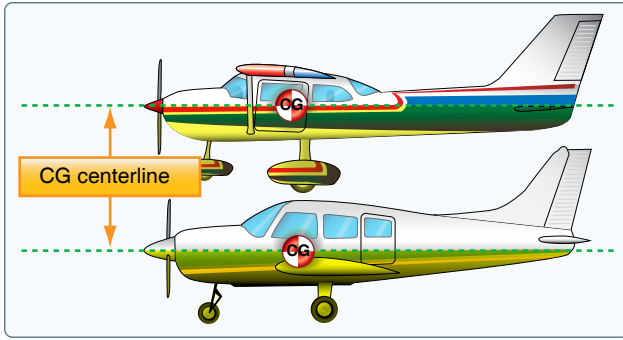

Figure 5-31. Keel area for lateral stability.

aircraft's weight and the pressure of the airflow against the upper portion of the keel area (both acting about the CG) tends to roll the aircraft back to wings-level flight.

### Directional Stability (Yawing)

Stability about the aircraft's vertical axis (the sideways moment) is called yawing or directional stability. Yawing or directional stability is the most easily achieved stability in aircraft design. The area of the vertical fin and the sides of the fuselage aft of the CG are the prime contributors that make the aircraft act like the well known weather vane or arrow, pointing its nose into the relative wind.

In examining a weather vane, it can be seen that if exactly the same amount of surface were exposed to the wind in front of the pivot point as behind it, the forces fore and aft would be in balance and little or no directional movement would result. Consequently, it is necessary to have a greater surface aft of the pivot point than forward of it.

Similarly, the aircraft designer must ensure positive directional stability by making the side surface greater aft than ahead of the CG. [Figure 5-32] To provide additional positive stability to that provided by the fuselage, a vertical fin is added. The fin acts similar to the feather on an arrow in maintaining straight flight. Like the weather vane and the arrow, the farther aft this fin is placed and the larger its size, the greater the aircraft's directional stability.

If an aircraft is flying in a straight line, and a sideward gust of air gives the aircraft a slight rotation about its vertical axis (i.e., the right), the motion is retarded and stopped by the fin because while the aircraft is rotating to the right, the air is striking the left side of the fin at an angle. This causes pressure on the left side of the fin, which resists the turning motion and slows down the aircraft's yaw. In doing so, it acts somewhat like the weather vane by turning the aircraft into the relative wind. The initial change in direction of the aircraft's flight path is generally slightly behind its change of heading. Therefore, after a slight yawing of the aircraft

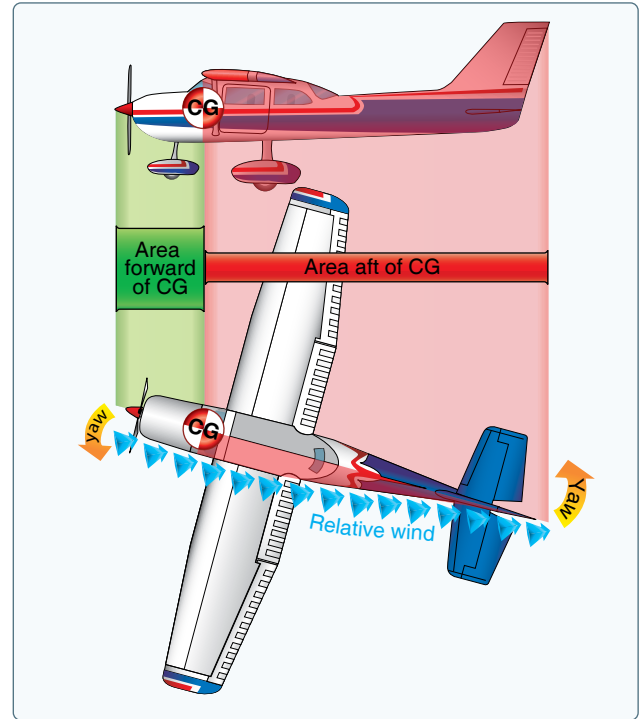

Figure 5-32. Fuselage and fin for directional stability.

to the right, there is a brief moment when the aircraft is still moving along its original path, but its longitudinal axis is pointed slightly to the right.

The aircraft is then momentarily skidding sideways and, during that moment (since it is assumed that although the yawing motion has stopped, the excess pressure on the left side of the fin still persists), there is necessarily a tendency for the aircraft to be turned partially back to the left. That is, there is a momentary restoring tendency caused by the fin.

This restoring tendency is relatively slow in developing and ceases when the aircraft stops skidding. When it ceases, the aircraft is flying in a direction slightly different from the original direction. In other words, it will not return of its own accord to the original heading; the pilot must reestablish the initial heading.

A minor improvement of directional stability may be obtained through sweepback. Sweepback is incorporated in the design of the wing primarily to delay the onset of compressibility during high-speed flight. In lighter and slower aircraft, sweepback aids in locating the center of pressure in the correct relationship with the CG. A longitudinally stable aircraft is built with the center of pressure aft of the CG.

Because of structural reasons, aircraft designers sometimes cannot attach the wings to the fuselage at the exact desired

point. If they had to mount the wings too far forward, and at right angles to the fuselage, the center of pressure would not be far enough to the rear to result in the desired amount of longitudinal stability. By building sweepback into the wings, however, the designers can move the center of pressure toward the rear. The amount of sweepback and the position of the wings then place the center of pressure in the correct location.

When turbulence or rudder application causes the aircraft to yaw to one side, the opposite wing presents a longer leading edge perpendicular to the relative airflow. The airspeed of the forward wing increases and it acquires more drag than the back wing. The additional drag on the forward wing pulls the wing back, turning the aircraft back to its original path.

The contribution of the wing to static directional stability is usually small. The swept wing provides a stable contribution depending on the amount of sweepback, but the contribution is relatively small when compared with other components.

### **Free Directional Oscillations (Dutch Roll)**

Dutch roll is a coupled lateral/directional oscillation that is usually dynamically stable but is unsafe in an aircraft because of the oscillatory nature. The damping of the oscillatory mode may be weak or strong depending on the properties of the particular aircraft.

If the aircraft has a right wing pushed down, the positive sideslip angle corrects the wing laterally before the nose is realigned with the relative wind. As the wing corrects the position, a lateral directional oscillation can occur resulting in the nose of the aircraft making a figure eight on the horizon as a result of two oscillations (roll and yaw), which, although of about the same magnitude, are out of phase with each other.

In most modern aircraft, except high-speed swept wing designs, these free directional oscillations usually die out automatically in very few cycles unless the air continues to be gusty or turbulent. Those aircraft with continuing Dutch roll tendencies are usually equipped with gyro-stabilized yaw dampers. Manufacturers try to reach a midpoint between too much and too little directional stability. Because it is more desirable for the aircraft to have “spiral instability” than Dutch roll tendencies, most aircraft are designed with that characteristic.

### **Spiral Instability**

Spiral instability exists when the static directional stability of the aircraft is very strong as compared to the effect of its dihedral in maintaining lateral equilibrium. When the lateral equilibrium of the aircraft is disturbed by a gust of air and a sideslip is introduced, the strong directional stability tends to yaw the nose into the resultant relative wind while the

comparatively weak dihedral lags in restoring the lateral balance. Due to this yaw, the wing on the outside of the turning moment travels forward faster than the inside wing and, as a consequence, its lift becomes greater. This produces an overbanking tendency which, if not corrected by the pilot, results in the bank angle becoming steeper and steeper. At the same time, the strong directional stability that yaws the aircraft into the relative wind is actually forcing the nose to a lower pitch attitude. A slow downward spiral begins which, if not counteracted by the pilot, gradually increases into a steep spiral dive. Usually the rate of divergence in the spiral motion is so gradual the pilot can control the tendency without any difficulty.

Many aircraft are affected to some degree by this characteristic, although they may be inherently stable in all other normal parameters. This tendency explains why an aircraft cannot be flown “hands off” indefinitely.

Much research has gone into the development of control devices (wing leveler) to correct or eliminate this instability. The pilot must be careful in application of recovery controls during advanced stages of this spiral condition or excessive loads may be imposed on the structure. Improper recovery from spiral instability leading to inflight structural failures has probably contributed to more fatalities in general aviation aircraft than any other factor. Since the airspeed in the spiral condition builds up rapidly, the application of back elevator force to reduce this speed and to pull the nose up only “tightens the turn,” increasing the load factor. The results of the prolonged uncontrolled spiral are inflight structural failure, crashing into the ground, or both. Common recorded causes for pilots who get into this situation are loss of horizon reference, inability to control the aircraft by reference to instruments, or a combination of both.

### **Effect of Wing Planform**

Understanding the effects of different wing planforms is important when learning about wing performance and airplane flight characteristics. A planform is the shape of the wing as viewed from directly above and deals with airflow in three dimensions. Aspect ratio, taper ratio, and sweepback are factors in planform design that are very important to the overall aerodynamic characteristic of a wing. [Figure 5-33]

Aspect ratio is the ratio of wing span to wing chord. Taper ratio can be either in planform or thickness, or both. In its simplest terms, it is a decrease from wing root to wingtip in wing chord or wing thickness. Sweepback is the rearward slant of a wing, horizontal tail, or other airfoil surface.

There are two general means by which the designer can change the planform of a wing and both will affect the

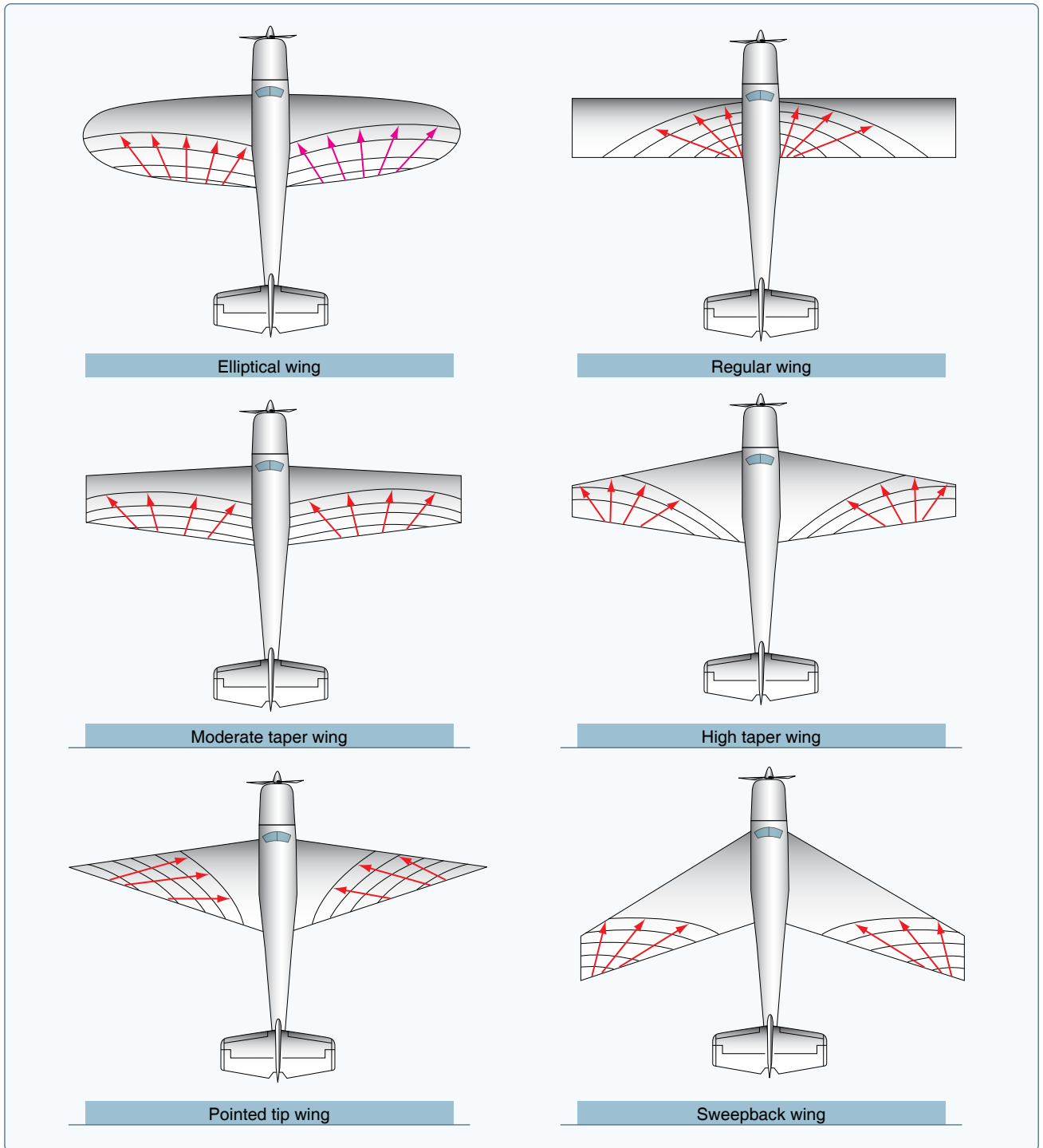

**Figure 5-33.** *Different types of wing planforms.*

aerodynamic characteristics of the wing. The first is to effect a change in the aspect ratio. Aspect ratio is the primary factor in determining the three dimensional characteristics of the ordinary wing and its lift/drag ratio. An increase in aspect ratio with constant velocity will decrease the drag, especially at high angles of attack, improving the performance of the wing when in a climbing attitude.

A decrease in aspect ratio will give a corresponding increase in drag. It should be noted, however, that with an increase in aspect ratio there is an increase in the length of span, with a corresponding increase in the weight of the wing structure, which means the wing must be heavier to carry the same load. For this reason, part of the gain (due to a decrease in drag) is lost because of the increased weight, and a compromise in

design is necessary to obtain the best results from these two conflicting conditions.

The second means of changing the planform is by tapering (decreasing the length of chord from the root to the tip of the wing). In general, tapering causes a decrease in drag (most effective at high speeds) and an increase in lift. There is also a structural benefit due to a saving in weight of the wing.

Most training and general aviation type airplanes are operated at high coefficients of lift, and therefore require comparatively high aspect ratios. Airplanes that are developed to operate at very high speeds demand greater aerodynamic cleanness and greater strength, which require low aspect ratios. Very low aspect ratios result in high wing loadings and high stall speeds. When sweepback is combined with low aspect ratio, it results in flying qualities very different from a more conventional high aspect ratio airplane configuration. Such airplanes require very precise and professional flying techniques, especially at slow speeds, while airplanes with a high aspect ratio are usually more forgiving of improper pilot techniques.

The elliptical wing is the ideal subsonic planform since it provides for a minimum of induced drag for a given aspect ratio, though as we shall see, its stall characteristics in some respects are inferior to the rectangular wing. It is also comparatively difficult to construct. The tapered airfoil is desirable from the standpoint of weight and stiffness, but again is not as efficient aerodynamically as the elliptical wing. In order to preserve the aerodynamic efficiency of the elliptical wing, rectangular and tapered wings are sometimes tailored through use of wing twist and variation in airfoil sections until they provide as nearly as possible the elliptical wing's lift distribution. While it is true that the elliptical wing provides the best coefficients of lift before reaching an incipient stall, it gives little advance warning of a complete stall, and lateral control may be difficult because of poor aileron effectiveness.

In comparison, the rectangular wing has a tendency to stall first at the wing root and provides adequate stall warning, adequate aileron effectiveness, and is usually quite stable. It is, therefore, favored in the design of low cost, low speed airplanes.

## Aerodynamic Forces in Flight Maneuvers

### Forces in Turns

If an aircraft were viewed in straight-and-level flight from the front [Figure 5-34], and if the forces acting on the aircraft could be seen, lift and weight would be apparent: two forces. If the aircraft were in a bank it would be apparent that lift did not act directly opposite to the weight, rather it now acts in the direction of the bank. A basic truth about turns is that when the aircraft banks, lift acts inward toward the center of the turn, perpendicular to the lateral axis as well as upward.

Newton's First Law of Motion, the Law of Inertia, states that an object at rest or moving in a straight line remains at rest or continues to move in a straight line until acted on by some other force. An aircraft, like any moving object, requires a sideward force to make it turn. In a normal turn, this force is supplied by banking the aircraft so that lift is exerted inward, as well as upward. The force of lift during a turn is separated into two components at right angles to each other. One component, which acts vertically and opposite to the weight (gravity), is called the "vertical component of lift." The other, which acts horizontally toward the center of the turn, is called the "horizontal component of lift" or centripetal force. The horizontal component of lift is the force that pulls the aircraft from a straight flight path to make it turn. Centrifugal force is the "equal and opposite reaction" of the aircraft to the change in direction and acts equal and opposite to the horizontal component of lift. This explains why, in a correctly executed turn, the force that turns the aircraft is not supplied by the rudder. The rudder is used to correct any deviation between the straight track of the nose and tail of the aircraft into the relative wind. A good turn is one in which the

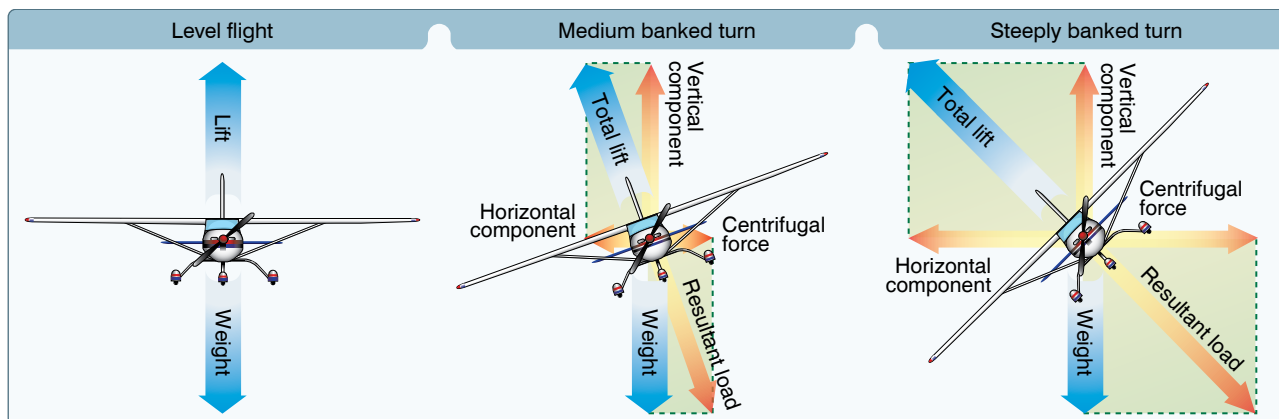

Figure 5-34. Forces during normal, coordinated turn at constant altitude.

nose and tail of the aircraft track along the same path. If no rudder is used in a turn, the nose of the aircraft yaws to the outside of the turn. The rudder is used rolling into the turn to bring the nose back in line with the relative wind. Once in the turn, the rudder should not be needed.

An aircraft is not steered like a boat or an automobile. In order for an aircraft to turn, it must be banked. If it is not banked, there is no force available to cause it to deviate from a straight flight path. Conversely, when an aircraft is banked, it turns provided it is not slipping to the inside of the turn. Good directional control is based on the fact that the aircraft attempts to turn whenever it is banked. Pilots should keep this fact in mind when attempting to hold the aircraft in straight-and-level flight.

Merely banking the aircraft into a turn produces no change in the total amount of lift developed. Since the lift during the bank is divided into vertical and horizontal components, the amount of lift opposing gravity and supporting the aircraft's weight is reduced. Consequently, the aircraft loses altitude unless additional lift is created. This is done by increasing the AOA until the vertical component of lift is again equal to the weight. Since the vertical component of lift decreases as the bank angle increases, the AOA must be progressively increased to produce sufficient vertical lift to support the aircraft's weight. An important fact for pilots to remember when making constant altitude turns is that the vertical component of lift must be equal to the weight to maintain altitude.

At a given airspeed, the rate at which an aircraft turns depends upon the magnitude of the horizontal component of lift. It is found that the horizontal component of lift is proportional to the angle of bank—that is, it increases or decreases respectively as the angle of bank increases or decreases. As the angle of bank is increased, the horizontal component of lift increases, thereby increasing the rate of turn (ROT). Consequently, at any given airspeed, the ROT can be controlled by adjusting the angle of bank.

To provide a vertical component of lift sufficient to hold altitude in a level turn, an increase in the AOA is required. Since the drag of the airfoil is directly proportional to its AOA, induced drag increases as the lift is increased. This, in turn, causes a loss of airspeed in proportion to the angle of bank. A small angle of bank results in a small reduction in airspeed while a large angle of bank results in a large reduction in airspeed. Additional thrust (power) must be applied to prevent a reduction in airspeed in level turns. The required amount of additional thrust is proportional to the angle of bank.

To compensate for added lift, which would result if the airspeed were increased during a turn, the AOA must be

decreased, or the angle of bank increased, if a constant altitude is to be maintained. If the angle of bank is held constant and the AOA decreased, the ROT decreases. In order to maintain a constant ROT as the airspeed is increased, the AOA must remain constant and the angle of bank increased.

An increase in airspeed results in an increase of the turn radius, and centrifugal force is directly proportional to the radius of the turn. In a correctly executed turn, the horizontal component of lift must be exactly equal and opposite to the centrifugal force. As the airspeed is increased in a constant-rate level turn, the radius of the turn increases. This increase in the radius of turn causes an increase in the centrifugal force, which must be balanced by an increase in the horizontal component of lift, which can only be increased by increasing the angle of bank.

In a slipping turn, the aircraft is not turning at the rate appropriate to the bank being used, since the aircraft is yawed toward the outside of the turning flight path. The aircraft is banked too much for the ROT, so the horizontal lift component is greater than the centrifugal force. [Figure 5-35] Equilibrium between the horizontal lift component and centrifugal force is reestablished by either decreasing the bank, increasing the ROT, or a combination of the two changes.

A skidding turn results from an excess of centrifugal force over the horizontal lift component, pulling the aircraft toward the outside of the turn. The ROT is too great for the angle of bank. Correction of a skidding turn thus involves a reduction in the ROT, an increase in bank, or a combination of the two changes.

To maintain a given ROT, the angle of bank must be varied with the airspeed. This becomes particularly important in high-speed aircraft. For instance, at 400 miles per hour (mph), an aircraft must be banked approximately 44° to execute a standard-rate turn (3° per second). At this angle of bank, only about 79 percent of the lift of the aircraft comprises the vertical component of the lift. This causes a loss of altitude unless the AOA is increased sufficiently to compensate for the loss of vertical lift.

### **Forces in Climbs**

For all practical purposes, the wing's lift in a steady state normal climb is the same as it is in a steady level flight at the same airspeed. Although the aircraft's flight path changed when the climb was established, the AOA of the wing with respect to the inclined flight path reverts to practically the same values, as does the lift. There is an initial momentary change as shown in Figure 5-36. During the transition from straight-and-level flight to a climb, a change in lift occurs when back elevator pressure is first applied. Raising the aircraft's nose increases the AOA and momentarily increases

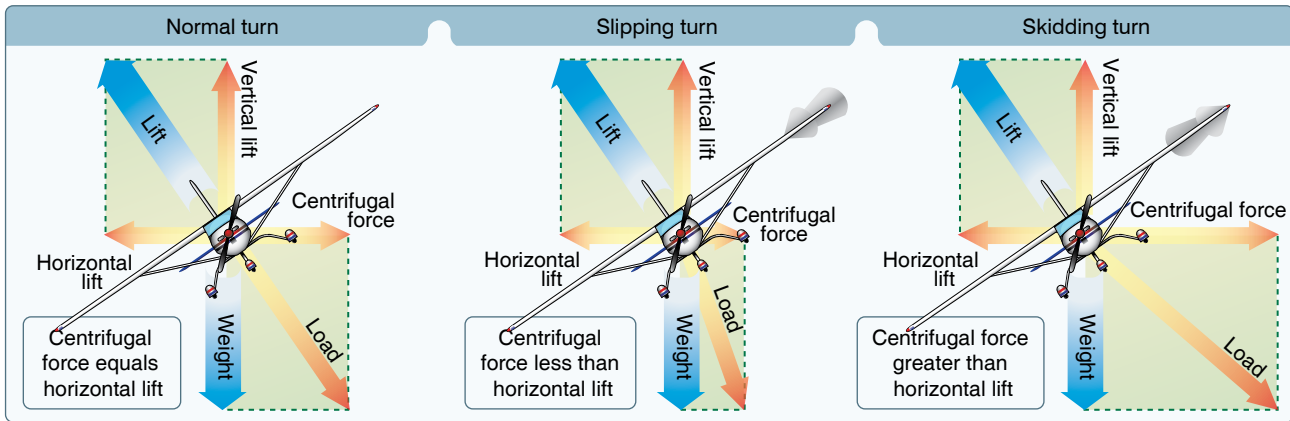

Figure 5-35. Normal, slipping, and skidding turns at a constant altitude.

the lift. Lift at this moment is now greater than weight and starts the aircraft climbing. After the flight path is stabilized on the upward incline, the AOA and lift again revert to about the level flight values.

If the climb is entered with no change in power setting, the airspeed gradually diminishes because the thrust required to maintain a given airspeed in level flight is insufficient to maintain the same airspeed in a climb. When the flight path is inclined upward, a component of the aircraft's weight acts in the same direction as, and parallel to, the total drag of the aircraft, thereby increasing the total effective drag. Consequently, the total effective drag is greater than the power, and the airspeed decreases. The reduction in airspeed gradually results in a corresponding decrease in drag until the total drag (including the component of weight acting in the same direction) equals the thrust. [Figure 5-37] Due to momentum, the change in airspeed is gradual, varying considerably with differences in aircraft size, weight, total drag, and other factors. Consequently, the total effective drag is greater than the thrust, and the airspeed decreases.

Generally, the forces of thrust and drag, and lift and weight, again become balanced when the airspeed stabilizes but at

a value lower than in straight-and-level flight at the same power setting. Since the aircraft's weight is acting not only downward but rearward with drag while in a climb, additional power is required to maintain the same airspeed as in level flight. The amount of power depends on the angle of climb. When the climb is established steep enough that there is insufficient power available, a slower speed results.

The thrust required for a stabilized climb equals drag plus a percentage of weight dependent on the angle of climb. For example, a 10° climb would require thrust to equal drag plus 17 percent of weight. To climb straight up would require thrust to equal all of weight and drag. Therefore, the angle of climb for climb performance is dependent on the amount of excess thrust available to overcome a portion of weight. Note that aircraft are able to sustain a climb due to excess thrust. When the excess thrust is gone, the aircraft is no longer able to climb. At this point, the aircraft has reached its "absolute ceiling."

### Forces in Descents

As in climbs, the forces that act on the aircraft go through definite changes when a descent is entered from straight-and-level flight. For the following example, the aircraft

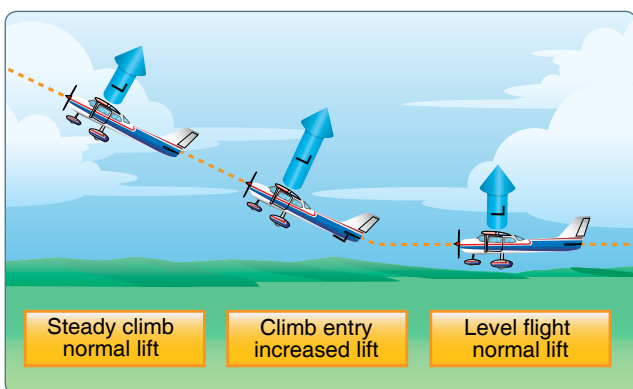

Figure 5-36. Changes in lift during climb entry.

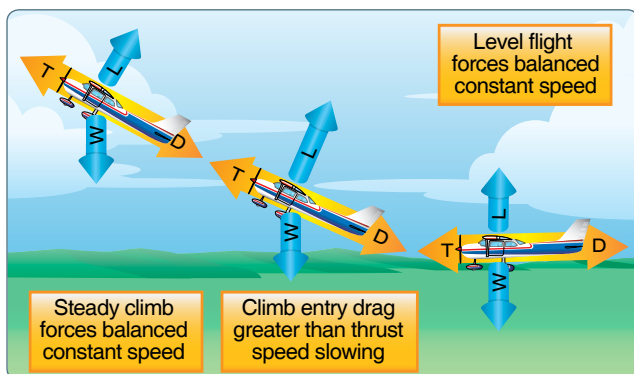

Figure 5-37. Changes in speed during climb entry.



is descending at the same power as used in straight-and-level flight.

As forward pressure is applied to the control yoke to initiate the descent, the AOA is decreased momentarily. Initially, the momentum of the aircraft causes the aircraft to briefly continue along the same flight path. For this instant, the AOA decreases causing the total lift to decrease. With weight now being greater than lift, the aircraft begins to descend. At the same time, the flight path goes from level to a descending flight path. Do not confuse a reduction in lift with the inability to generate sufficient lift to maintain level flight. The flight path is being manipulated with available thrust in reserve and with the elevator.

To descend at the same airspeed as used in straight-and-level flight, the power must be reduced as the descent is entered. Entering the descent, the component of weight acting forward along the flight path increases as the angle of descent increases and, conversely, when leveling off, the component of weight acting along the flight path decreases as the angle of descent decreases.

## Stalls

An aircraft stall results from a rapid decrease in lift caused by the separation of airflow from the wing's surface brought on by exceeding the critical AOA. A stall can occur at any pitch attitude or airspeed. Stalls are one of the most misunderstood areas of aerodynamics because pilots often believe an airfoil stops producing lift when it stalls. In a stall, the wing does not totally stop producing lift. Rather, it cannot generate adequate lift to sustain level flight.

Since the  $C_L$  increases with an increase in AOA, at some point the  $C_L$  peaks and then begins to drop off. This peak is called the  $C_{L-MAX}$ . The amount of lift the wing produces drops dramatically after exceeding the  $C_{L-MAX}$  or critical AOA, but as stated above, it does not completely stop producing lift.

In most straight-wing aircraft, the wing is designed to stall the wing root first. The wing root reaches its critical AOA first making the stall progress outward toward the wingtip. By having the wing root stall first, aileron effectiveness is maintained at the wingtips, maintaining controllability of the aircraft. Various design methods are used to achieve the stalling of the wing root first. In one design, the wing is "twisted" to a higher AOA at the wing root. Installing stall strips on the first 20–25 percent of the wing's leading edge is another method to introduce a stall prematurely.

The wing never completely stops producing lift in a stalled condition. If it did, the aircraft would fall to the Earth. Most training aircraft are designed for the nose of the aircraft to

drop during a stall, reducing the AOA and "unstalling" the wing. The nose-down tendency is due to the CL being aft of the CG. The CG range is very important when it comes to stall recovery characteristics. If an aircraft is allowed to be operated outside of the CG range, the pilot may have difficulty recovering from a stall. The most critical CG violation would occur when operating with a CG that exceeds the rear limit. In this situation, a pilot may not be able to generate sufficient force with the elevator to counteract the excess weight aft of the CG. Without the ability to decrease the AOA, the aircraft continues in a stalled condition until it contacts the ground.

The stalling speed of a particular aircraft is not a fixed value for all flight situations, but a given aircraft always stalls at the same AOA regardless of airspeed, weight, load factor, or density altitude. Each aircraft has a particular AOA where the airflow separates from the upper surface of the wing and the stall occurs. This critical AOA varies from approximately 16° to 20° depending on the aircraft's design. But each aircraft has only one specific AOA where the stall occurs.

There are three flight situations in which the critical AOA is most frequently exceeded: low speed, high speed, and turning.

One way the aircraft can be stalled in straight-and-level flight by flying too slowly. As the airspeed decreases, the AOA must be increased to retain the lift required for maintaining altitude. The lower the airspeed becomes, the more the AOA must be increased. Eventually, an AOA is reached that results in the wing not producing enough lift to support the aircraft, which then starts settling. If the airspeed is reduced further, the aircraft stalls because the AOA has exceeded the critical angle and the airflow over the wing is disrupted.

Low speed is not necessary to produce a stall. The wing can be brought into an excessive AOA at any speed. For example, an aircraft is in a dive with an airspeed of 100 knots when the pilot pulls back sharply on the elevator control. [Figure 5-38] Gravity and centrifugal force prevent an immediate alteration of the flight path, but the aircraft's AOA changes abruptly from quite low to very high. Since the flight path of the aircraft in relation to the oncoming air determines the direction of the relative wind, the AOA is suddenly increased, and the aircraft would reach the stalling angle at a speed much greater than the normal stall speed.

The stalling speed of an aircraft is also higher in a level turn than in straight-and-level flight. [Figure 5-39] Centrifugal force is added to the aircraft's weight and the wing must produce sufficient additional lift to counterbalance the load imposed by the combination of centrifugal force and weight. In a turn, the necessary additional lift is acquired by applying back pressure to the elevator control. This increases the wing's

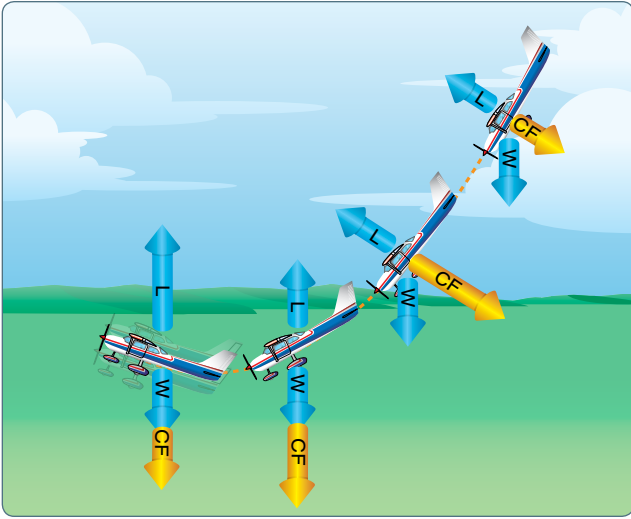

**Figure 5-38.** Forces exerted when pulling out of a dive.

AOA and results in increased lift. The AOA must increase as the bank angle increases to counteract the increasing load caused by centrifugal force. If at any time during a turn the AOA becomes excessive, the aircraft stalls.

At this point, the action of the aircraft during a stall should be examined. To balance the aircraft aerodynamically, the CL is normally located aft of the CG. Although this makes the aircraft inherently nose-heavy, downwash on the horizontal stabilizer counteracts this condition. At the point of stall, when the upward force of the wing's lift diminishes below that required for sustained flight and the downward tail force decreases to a point of ineffectiveness, or causes it to have an upward force, an unbalanced condition exists. This causes the aircraft to pitch down abruptly, rotating about its CG. During this nose-down attitude, the AOA decreases and the airspeed again increases. The smooth flow of air over the wing begins again, lift returns, and the aircraft begins to fly again. Considerable altitude may be lost before this cycle is complete.

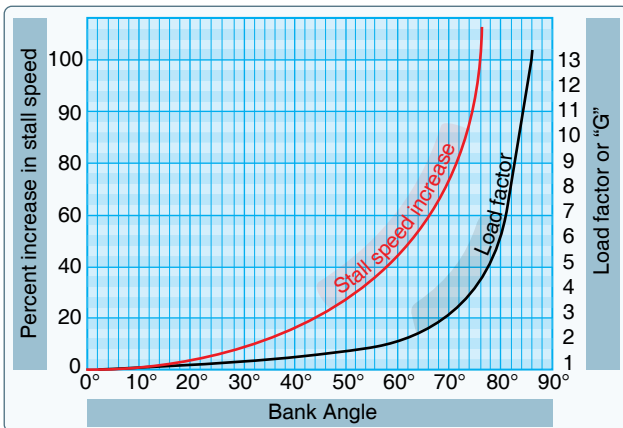

**Figure 5-39.** Increase in stall speed and load factor.

Airfoil shape and degradation of that shape must also be considered in a discussion of stalls. For example, if ice, snow, and frost are allowed to accumulate on the surface of an aircraft, the smooth airflow over the wing is disrupted. This causes the boundary layer to separate at an AOA lower than that of the critical angle. Lift is greatly reduced, altering expected aircraft performance. If ice is allowed to accumulate on the aircraft during flight, the weight of the aircraft is increased while the ability to generate lift is decreased. [Figure 5-40] As little as 0.8 millimeter of ice on the upper wing surface increases drag and reduces aircraft lift by 25 percent.

Pilots can encounter icing in any season, anywhere in the country, at altitudes of up to 18,000 feet and sometimes higher. Small aircraft, including commuter planes, are most vulnerable because they fly at lower altitudes where ice is more prevalent. They also lack mechanisms common on jet aircraft that prevent ice buildup by heating the front edges of wings.

Icing can occur in clouds any time the temperature drops below freezing and super-cooled droplets build up on an aircraft and freeze. (Super-cooled droplets are still liquid even though the temperature is below 32 °Fahrenheit (F), or 0 °Celsius (C).

### Angle of Attack Indicators

The FAA along with the General Aviation Joint Steering Committee (GAJSC) is promoting AOA indicators as one of the many safety initiatives aimed at reducing the general aviation accident rate. AOA indicators will specifically target Loss of Control (LOC) accidents. Loss of control is the number one root cause of fatalities in both general aviation and commercial aviation. More than 25 percent of general aviation fatal accidents occur during the maneuvering phase of flight. Of those accidents, half involve stall/spin scenarios. Technology such as AOA indicators can have a tremendous impact on reversing this trend and are increasingly affordable for general aviation airplanes. [Figure 5-41]

The purpose of an AOA indicator is to give the pilot better situation awareness pertaining to the aerodynamic health



**Figure 5-40.** Inflight ice formation.

of the airfoil. This can also be referred to as stall margin awareness. More simply explained, it is the margin that exists between the current AOA that the airfoil is operating at, and the AOA at which the airfoil will stall (critical AOA).

Angle of attack is taught to student pilots as theory in ground training. When beginning flight training, students typically rely solely on airspeed and the published 1G stall speed to avoid stalls. This creates problems since this speed is only valid when the following conditions are met:

- Unaccelerated flight (a 1G load factor)
- Coordinated flight (inclinometer centered)
- At one weight (typically maximum gross weight)

Speed by itself is not a reliable parameter to avoid a stall. An airplane can stall at any speed. Angle of attack is a better parameter to use to avoid a stall. For a given configuration, the airplane always stalls at the same AOA, referred to as the critical AOA. This critical AOA does not change with:

- Weight
- Bank angle
- Temperature
- Density altitude
- Center of gravity

An AOA indicator can have several benefits when installed in general aviation aircraft, not the least of which is increased situational awareness. Without an AOA indicator, the AOA is “invisible” to pilots. These devices measure several parameters simultaneously and determine the current AOA providing a visual image to the pilot of the current AOA along with representations of the proximity to the critical AOA. [Figure 5-42] These devices can give a visual representation of the energy management state of the airplane. The energy

state of an airplane is the balance between airspeed, altitude, drag, and thrust and represents how efficiently the airfoil is operating. The more efficiently the airfoil operates; the larger stall margin that is present. With this increased situational awareness pertaining to the energy condition of the airplane, pilots will have information that they need to aid in preventing a LOC scenario resulting from a stall/spin. Additionally, the less energy that is utilized to maintain flight means greater overall efficiency of the airplane, which is typically realized in fuel savings. This equates to a lower operating cost to the pilot.

Just as training is required for any system on an aircraft, AOA indicators have training considerations also. A more comprehensive understanding of AOA in general should be the goal of this training along with the specific operating characteristics and limitations of the installed AOA indicator. Ground and flight instructors should make every attempt to receive training from an instructor knowledgeable about AOA indicators prior to giving instruction pertaining to or in airplanes equipped with AOA indicators. Pilot schools should incorporate training on AOA indicators in their syllabi, whether their training aircraft are equipped with them or not.

Installation of AOA indicators not required by type certification in general aviation airplanes has recently been streamlined by the FAA. The FAA established policy in February 2014 pertaining to non-required AOA systems and how they may be installed as a minor alteration, depending upon their installation requirements and operational utilization, and the procedures to take for certification of these installations. For updated information, reference the FAA website at [www.faa.gov](http://www.faa.gov).

While AOA indicators provide a simple visual representation of the current AOA and its proximity to the critical AOA, they are not without their limitations. These limitations should be understood by operators of general aviation airplanes



Figure 5-41. A variety of AOA indicators.

## Coefficient of Lift Curve

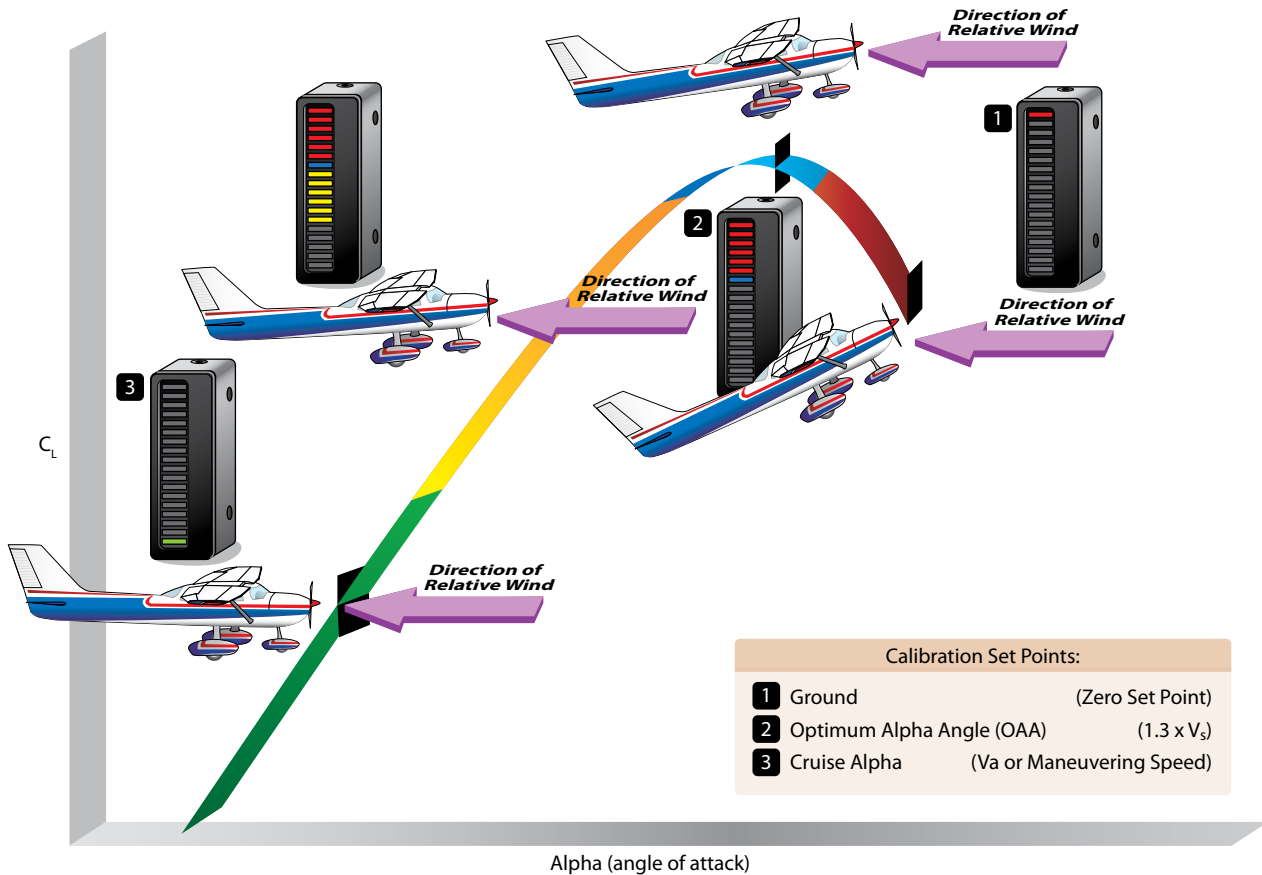

**Figure 5-42.** An AOA indicator has several benefits when installed in general aviation aircraft.

equipped with these devices. Like advanced automation, such as autopilots and moving maps, the misunderstanding or misuse of the equipment can have disastrous results. Some items which may limit the effectiveness of an AOA indicator are listed below:

- Calibration techniques
- Probes or vanes not being heated
- The type of indicator itself
- Flap setting
- Wing contamination

Pilots of general aviation airplanes equipped with AOA indicators should contact the manufacturer for specific limitations applicable to that installation.

### Basic Propeller Principles

The aircraft propeller consists of two or more blades and a central hub to which the blades are attached. Each blade of an aircraft propeller is essentially a rotating wing. As a result of their construction, the propeller blades are like airfoils

and produce forces that create the thrust to pull, or push, the aircraft through the air. The engine furnishes the power needed to rotate the propeller blades through the air at high speeds, and the propeller transforms the rotary power of the engine into forward thrust.

A cross-section of a typical propeller blade is shown in *Figure 5-43*. This section or blade element is an airfoil comparable to a cross-section of an aircraft wing. One surface of the blade is cambered or curved, similar to the upper surface of an aircraft wing, while the other surface is flat like the bottom surface of a wing. The chord line is an imaginary line drawn through the blade from its leading edge to its trailing edge. As in a wing, the leading edge is the thick edge of the blade that meets the air as the propeller rotates. Blade angle, usually measured in degrees, is the angle between the chord of the blade and the plane of rotation and is measured at a specific point along the length of the blade. [Figure 5-44] Because most propellers have a flat blade “face,” the chord line is often drawn along the face of the propeller blade. Pitch is not blade angle, but because pitch is largely determined by blade angle, the two terms are

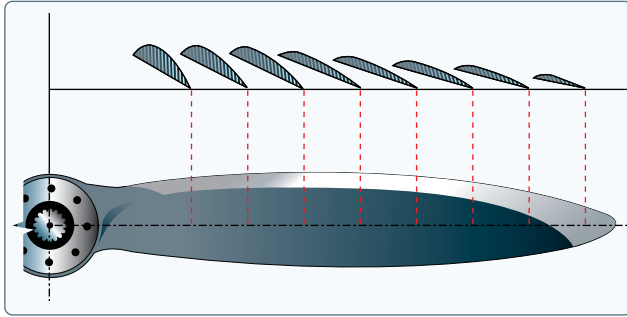

**Figure 5-43.** Airfoil sections of propeller blade.

often used interchangeably. An increase or decrease in one is usually associated with an increase or decrease in the other. The pitch of a propeller may be designated in inches. A propeller designated as a “74–48” would be 74 inches in length and have an effective pitch of 48 inches. The pitch is the distance in inches, which the propeller would screw through the air in one revolution if there were no slippage.

When specifying a fixed-pitch propeller for a new type of aircraft, the manufacturer usually selects one with a pitch that operates efficiently at the expected cruising speed of the aircraft. Every fixed-pitch propeller must be a compromise because it can be efficient at only a given combination of airspeed and revolutions per minute (rpm). Pilots cannot change this combination in flight.

When the aircraft is at rest on the ground with the engine operating, or moving slowly at the beginning of takeoff, the propeller efficiency is very low because the propeller is restrained from advancing with sufficient speed to permit its fixed-pitch blades to reach their full efficiency. In this situation, each propeller blade is turning through the air at an AOA that produces relatively little thrust for the amount of power required to turn it.

To understand the action of a propeller, consider first its motion, which is both rotational and forward. As shown by

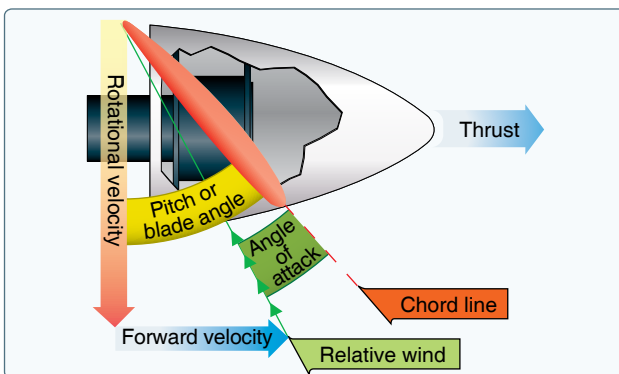

**Figure 5-44.** Propeller blade angle.

the vectors of propeller forces in *Figure 5-44*, each section of a propeller blade moves downward and forward. The angle at which this air (relative wind) strikes the propeller blade is its AOA. The air deflection produced by this angle causes the dynamic pressure at the engine side of the propeller blade to be greater than atmospheric pressure, thus creating thrust.

The shape of the blade also creates thrust because it is cambered like the airfoil shape of a wing. As the air flows past the propeller, the pressure on one side is less than that on the other. As in a wing, a reaction force is produced in the direction of the lesser pressure. The airflow over the wing has less pressure, and the force (lift) is upward. In the case of the propeller, which is mounted in a vertical instead of a horizontal plane, the area of decreased pressure is in front of the propeller, and the force (thrust) is in a forward direction. Aerodynamically, thrust is the result of the propeller shape and the AOA of the blade.

Thrust can be considered also in terms of the mass of air handled by the propeller. In these terms, thrust equals mass of air handled multiplied by slipstream velocity minus velocity of the aircraft. The power expended in producing thrust depends on the rate of air mass movement. On average, thrust constitutes approximately 80 percent of the torque (total horsepower absorbed by the propeller). The other 20 percent is lost in friction and slippage. For any speed of rotation, the horsepower absorbed by the propeller balances the horsepower delivered by the engine. For any single revolution of the propeller, the amount of air handled depends on the blade angle, which determines how big a “bite” of air the propeller takes. Thus, the blade angle is an excellent means of adjusting the load on the propeller to control the engine rpm.

The blade angle is also an excellent method of adjusting the AOA of the propeller. On constant-speed propellers, the blade angle must be adjusted to provide the most efficient AOA at all engine and aircraft speeds. Lift versus drag curves, which are drawn for propellers as well as wings, indicate that the most efficient AOA is small, varying from +2° to +4°. The actual blade angle necessary to maintain this small AOA varies with the forward speed of the aircraft.

Fixed-pitch and ground-adjustable propellers are designed for best efficiency at one rotation and forward speed. They are designed for a given aircraft and engine combination. A propeller may be used that provides the maximum efficiency for takeoff, climb, cruise, or high-speed flight. Any change in these conditions results in lowering the efficiency of both the propeller and the engine. Since the efficiency of any machine is the ratio of the useful power output to the actual power input, propeller efficiency is the ratio of thrust horsepower to brake horsepower. Propeller efficiency varies from 50 to

87 percent, depending on how much the propeller “slips.” Propeller slip is the difference between the geometric pitch of the propeller and its effective pitch. [Figure 5-45] Geometric pitch is the theoretical distance a propeller should advance in one revolution; effective pitch is the distance it actually advances. Thus, geometric or theoretical pitch is based on no slippage, but actual or effective pitch includes propeller slippage in the air.

The reason a propeller is “twisted” is that the outer parts of the propeller blades, like all things that turn about a central point, travel faster than the portions near the hub. [Figure 5-46] If the blades had the same geometric pitch throughout their lengths, portions near the hub could have negative AOAs while the propeller tips would be stalled at cruise speed. Twisting or variations in the geometric pitch of the blades permits the propeller to operate with a relatively constant AOA along its length when in cruising flight. Propeller blades are twisted to change the blade angle in proportion to the differences in speed of rotation along the length of the propeller, keeping thrust more nearly equalized along this length.

Usually  $1^\circ$  to  $4^\circ$  provides the most efficient lift/drag ratio, but in flight the propeller AOA of a fixed-pitch propeller varies—normally from  $0^\circ$  to  $15^\circ$ . This variation is caused by changes in the relative airstream, which in turn results from changes in aircraft speed. Thus, propeller AOA is the product of two motions: propeller rotation about its axis and its forward motion.

A constant-speed propeller automatically keeps the blade angle adjusted for maximum efficiency for most conditions encountered in flight. During takeoff, when maximum power and thrust are required, the constant-speed propeller is at a low propeller blade angle or pitch. The low blade angle keeps the AOA small and efficient with respect to the relative wind. At the same time, it allows the propeller to handle a smaller mass of air per revolution. This light load allows the engine to turn at high rpm and to convert the maximum amount of fuel into heat energy in a given time. The high rpm also creates maximum thrust because, although the mass of air handled per revolution is small, the rpm and slipstream velocity are

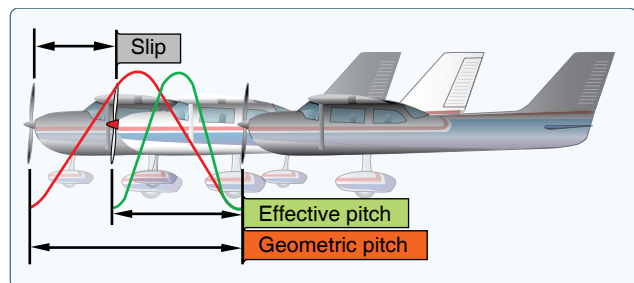

Figure 5-45. Propeller slippage.

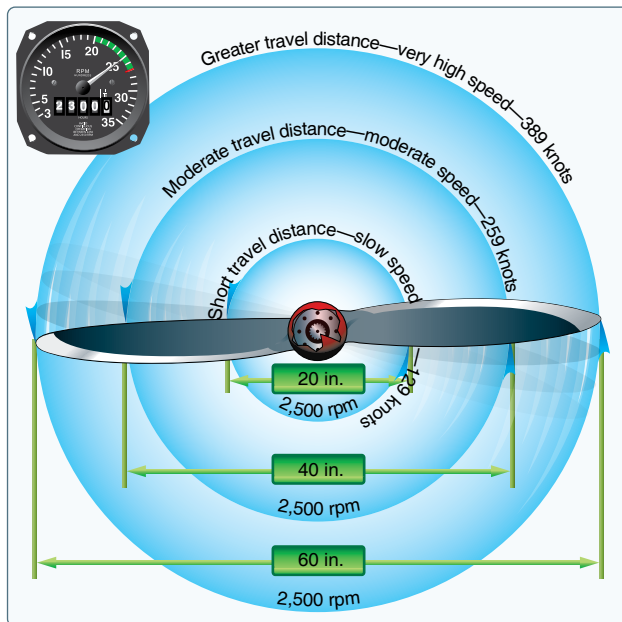

Figure 5-46. Propeller tips travel faster than the hub.

high, and with the low aircraft speed, there is maximum thrust. After liftoff, as the speed of the aircraft increases, the constant-speed propeller automatically changes to a higher angle (or pitch). Again, the higher blade angle keeps the AOA small and efficient with respect to the relative wind. The higher blade angle increases the mass of air handled per revolution. This decreases the engine rpm, reducing fuel consumption and engine wear, and keeps thrust at a maximum.

After the takeoff climb is established in an aircraft having a controllable-pitch propeller, the pilot reduces the power output of the engine to climb power by first decreasing the manifold pressure and then increasing the blade angle to lower the rpm.

At cruising altitude, when the aircraft is in level flight and less power is required than is used in takeoff or climb, the pilot again reduces engine power by reducing the manifold pressure and then increasing the blade angle to decrease the rpm. Again, this provides a torque requirement to match the reduced engine power. Although the mass of air handled per revolution is greater, it is more than offset by a decrease in slipstream velocity and an increase in airspeed. The AOA is still small because the blade angle has been increased with an increase in airspeed.

### Torque and P-Factor

To the pilot, “torque” (the left turning tendency of the airplane) is made up of four elements that cause or produce a twisting or rotating motion around at least one of the airplane’s three axes. These four elements are:

1. Torque reaction from engine and propeller

2. Corkscrewing effect of the slipstream
3. Gyroscopic action of the propeller
4. Asymmetric loading of the propeller (P-factor)

### Torque Reaction

Torque reaction involves Newton’s Third Law of Physics— for every action, there is an equal and opposite reaction. As applied to the aircraft, this means that as the internal engine parts and propeller are revolving in one direction, an equal force is trying to rotate the aircraft in the opposite direction. [Figure 5-47]

When the aircraft is airborne, this force is acting around the longitudinal axis, tending to make the aircraft roll. To compensate for roll tendency, some of the older aircraft are rigged in a manner to create more lift on the wing that is being forced downward. The more modern aircraft are designed with the engine offset to counteract this effect of torque.

NOTE: Most United States built aircraft engines rotate the propeller clockwise, as viewed from the pilot’s seat. The discussion here is with reference to those engines.

Generally, the compensating factors are permanently set so that they compensate for this force at cruising speed, since most of the aircraft’s operating time is at that speed. However, aileron trim tabs permit further adjustment for other speeds. When the aircraft’s wheels are on the ground during the takeoff roll, an additional turning moment around the vertical axis is induced by torque reaction. As the left side of the aircraft is being forced down by torque reaction, more weight is being placed on the left main landing gear. This results in more ground friction, or drag, on the left tire than on the right, causing a further turning moment to the left. The magnitude of this moment is dependent on many variables. Some of these variables are:

1. Size and horsepower of engine
2. Size of propeller and the rpm
3. Size of the aircraft
4. Condition of the ground surface

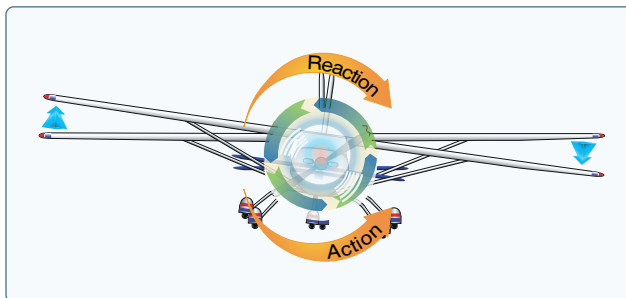

Figure 5-47. Torque reaction.

This yawing moment on the takeoff roll is corrected by the pilot’s proper use of the rudder or rudder trim.

### Corkscrew Effect

The high-speed rotation of an aircraft propeller gives a corkscrew or spiraling rotation to the slipstream. At high propeller speeds and low forward speed (as in the takeoffs and approaches to power-on stalls), this spiraling rotation is very compact and exerts a strong sideward force on the aircraft’s vertical tail surface. [Figure 5-48]

When this spiraling slipstream strikes the vertical fin, it causes a yawing moment about the aircraft’s vertical axis. The more compact the spiral, the more prominent this force is. As the forward speed increases, however, the spiral elongates and becomes less effective. The corkscrew flow of the slipstream also causes a rolling moment around the longitudinal axis.

Note that this rolling moment caused by the corkscrew flow of the slipstream is to the right, while the yawing moment caused by torque reaction is to the left—in effect one may be counteracting the other. However, these forces vary greatly and it is the pilot’s responsibility to apply proper corrective action by use of the flight controls at all times. These forces must be counteracted regardless of which is the most prominent at the time.

### Gyroscopic Action

Before the gyroscopic effects of the propeller can be understood, it is necessary to understand the basic principle of a gyroscope. All practical applications of the gyroscope are based upon two fundamental properties of gyroscopic action: rigidity in space and precession. The one of interest for this discussion is precession.

Precession is the resultant action, or deflection, of a spinning rotor when a deflecting force is applied to its rim. As can be seen in Figure 5-49, when a force is applied, the resulting force takes effect 90° ahead of and in the direction of rotation. The rotating propeller of an airplane makes a very good

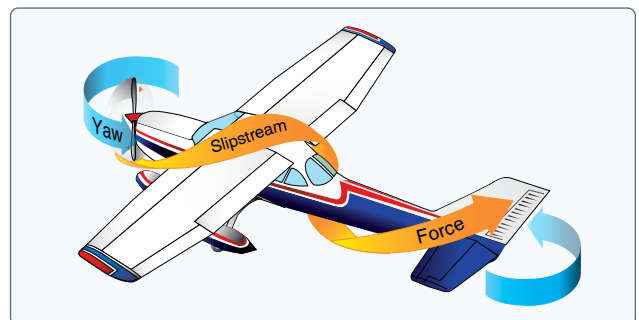

Figure 5-48. Corkscrewing slipstream.

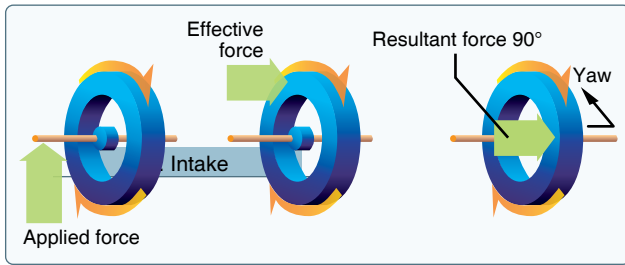

Figure 5-49. Gyroscopic precession.

gyroscope and thus has similar properties. Any time a force is applied to deflect the propeller out of its plane of rotation, the resulting force is 90° ahead of and in the direction of rotation and in the direction of application, causing a pitching moment, a yawing moment, or a combination of the two depending upon the point at which the force was applied.

This element of torque effect has always been associated with and considered more prominent in tailwheel-type aircraft and most often occurs when the tail is being raised during the takeoff roll. [Figure 5-50] This change in pitch attitude has the same effect as applying a force to the top of the propeller's plane of rotation. The resultant force acting 90° ahead causes a yawing moment to the left around the vertical axis. The magnitude of this moment depends on several variables, one of which is the abruptness with which the tail is raised (amount of force applied). However, precession, or gyroscopic action, occurs when a force is applied to any point on the rim of the propeller's plane of rotation; the resultant force will still be 90° from the point of application in the direction of rotation. Depending on where the force is applied, the airplane is caused to yaw left or right, to pitch up or down, or a combination of pitching and yawing.

It can be said that, as a result of gyroscopic action, any yawing around the vertical axis results in a pitching moment, and any pitching around the lateral axis results in a yawing moment. To correct for the effect of gyroscopic action, it is necessary for the pilot to properly use elevator and rudder to prevent undesired pitching and yawing.

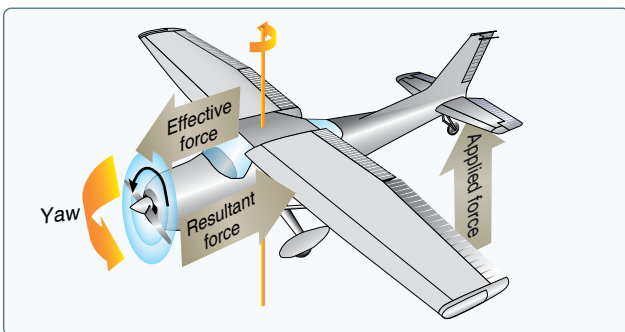

Figure 5-50. Raising tail produces gyroscopic precession.

### Asymmetric Loading (P-Factor)

When an aircraft is flying with a high AOA, the “bite” of the downward moving blade is greater than the “bite” of the upward moving blade. This moves the center of thrust to the right of the prop disc area, causing a yawing moment toward the left around the vertical axis. Proving this explanation is complex because it would be necessary to work wind vector problems on each blade while considering both the AOA of the aircraft and the AOA of each blade.

This asymmetric loading is caused by the resultant velocity, which is generated by the combination of the velocity of the propeller blade in its plane of rotation and the velocity of the air passing horizontally through the propeller disc. With the aircraft being flown at positive AOAs, the right (viewed from the rear) or downswinging blade, is passing through an area of resultant velocity, which is greater than that affecting the left or upswinging blade. Since the propeller blade is an airfoil, increased velocity means increased lift. The downswinging blade has more lift and tends to pull (yaw) the aircraft's nose to the left.

When the aircraft is flying at a high AOA, the downward moving blade has a higher resultant velocity, creating more lift than the upward moving blade. [Figure 5-51] This might be easier to visualize if the propeller shaft was mounted perpendicular to the ground (like a helicopter). If there were no air movement at all, except that generated by the propeller itself, identical sections of each blade would have the same airspeed. With air moving horizontally across this vertically mounted propeller, the blade proceeding forward into the flow of air has a higher airspeed than the blade retreating with the airflow. Thus, the blade proceeding into the horizontal airflow is creating more lift, or thrust, moving the center of thrust toward that blade. Visualize rotating the vertically mounted propeller shaft to shallower angles relative to the moving air (as on an aircraft). This unbalanced thrust then becomes proportionately smaller and continues getting smaller until it reaches the value of zero when the propeller shaft is exactly horizontal in relation to the moving air.

The effects of each of these four elements of torque vary in value with changes in flight situations. In one phase of flight, one of these elements may be more prominent than another. In another phase of flight, another element may be more prominent. The relationship of these values to each other varies with different aircraft depending on the airframe, engine, and propeller combinations, as well as other design features. To maintain positive control of the aircraft in all flight conditions, the pilot must apply the flight controls as necessary to compensate for these varying values.



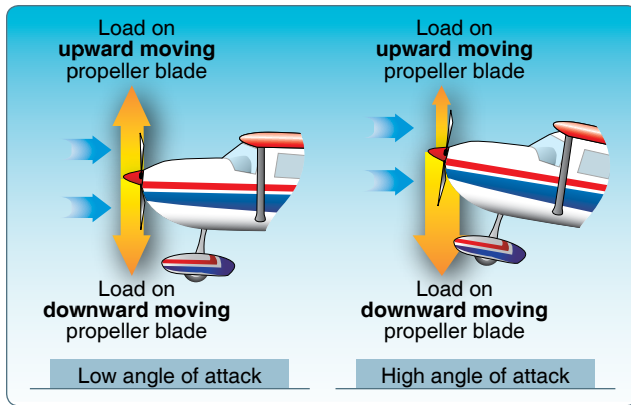

Figure 5-51. Asymmetrical loading of propeller (*P-factor*).

## Load Factors

In aerodynamics, the maximum load factor (at given bank angle) is a proportion between lift and weight and has a trigonometric relationship. The load factor is measured in Gs (acceleration of gravity), a unit of force equal to the force exerted by gravity on a body at rest and indicates the force to which a body is subjected when it is accelerated. Any force applied to an aircraft to deflect its flight from a straight line produces a stress on its structure. The amount of this force is the load factor. While a course in aerodynamics is not a prerequisite for obtaining a pilot's license, the competent pilot should have a solid understanding of the forces that act on the aircraft, the advantageous use of these forces, and the operating limitations of the aircraft being flown.

For example, a load factor of 3 means the total load on an aircraft's structure is three times its weight. Since load factors are expressed in terms of Gs, a load factor of 3 may be spoken of as 3 Gs, or a load factor of 4 as 4 Gs.

If an aircraft is pulled up from a dive, subjecting the pilot to 3 Gs, he or she would be pressed down into the seat with a force equal to three times his or her weight. Since modern aircraft operate at significantly higher speeds than older aircraft, increasing the potential for large load factors, this effect has become a primary consideration in the design of the structure of all aircraft.

With the structural design of aircraft planned to withstand only a certain amount of overload, a knowledge of load factors has become essential for all pilots. Load factors are important for two reasons:

1. It is possible for a pilot to impose a dangerous overload on the aircraft structures.
2. An increased load factor increases the stalling speed and makes stalls possible at seemingly safe flight speeds.

## Load Factors in Aircraft Design

The answer to the question "How strong should an aircraft be?" is determined largely by the use to which the aircraft is subjected. This is a difficult problem because the maximum possible loads are much too high for use in efficient design. It is true that any pilot can make a very hard landing or an extremely sharp pull up from a dive, which would result in abnormal loads. However, such extremely abnormal loads must be dismissed somewhat if aircraft are built that take off quickly, land slowly, and carry worthwhile payloads.

The problem of load factors in aircraft design becomes how to determine the highest load factors that can be expected in normal operation under various operational situations. These load factors are called "limit load factors." For reasons of safety, it is required that the aircraft be designed to withstand these load factors without any structural damage. Although the Code of Federal Regulations (CFR) requires the aircraft structure be capable of supporting one and one-half times these limit load factors without failure, it is accepted that parts of the aircraft may bend or twist under these loads and that some structural damage may occur.

This 1.5 load limit factor is called the "factor of safety" and provides, to some extent, for loads higher than those expected under normal and reasonable operation. This strength reserve is not something that pilots should willfully abuse; rather, it is there for protection when encountering unexpected conditions.

The above considerations apply to all loading conditions, whether they be due to gusts, maneuvers, or landings. The gust load factor requirements now in effect are substantially the same as those that have been in existence for years. Hundreds of thousands of operational hours have proven them adequate for safety. Since the pilot has little control over gust load factors (except to reduce the aircraft's speed when rough air is encountered), the gust loading requirements are substantially the same for most general aviation type aircraft regardless of their operational use. Generally, the gust load factors control the design of aircraft which are intended for strictly nonacrobatic usage.

An entirely different situation exists in aircraft design with maneuvering load factors. It is necessary to discuss this matter separately with respect to: (1) aircraft designed in accordance with the category system (i.e., normal, utility, acrobatic); and (2) older designs built according to requirements that did not provide for operational categories.

Aircraft designed under the category system are readily identified by a placard in the flight deck, which states the operational category (or categories) in which the aircraft

is certificated. The maximum safe load factors (limit load factors) specified for aircraft in the various categories are:

CATEGORY	LIMIT LOAD FACTOR
Normal <sup>1</sup>	3.8 to -1.52
Utility (mild acrobatics, including spins)	4.4 to -1.76
Acrobatic	6.0 to -3.00

<sup>1</sup> For aircraft with gross weight of more than 4,000 pounds, the limit load factor is reduced. To the limit loads given above, a safety factor of 50 percent is added.

There is an upward graduation in load factor with the increasing severity of maneuvers. The category system provides for maximum utility of an aircraft. If normal operation alone is intended, the required load factor (and consequently the weight of the aircraft) is less than if the aircraft is to be employed in training or acrobatic maneuvers as they result in higher maneuvering loads.

Aircraft that do not have the category placard are designs that were constructed under earlier engineering requirements in which no operational restrictions were specifically given to the pilots. For aircraft of this type (up to weights of about 4,000 pounds), the required strength is comparable to present-day utility category aircraft, and the same types of operation are permissible. For aircraft of this type over 4,000 pounds, the load factors decrease with weight. These aircraft should be regarded as being comparable to the normal category aircraft designed under the category system, and they should be operated accordingly.

### Load Factors in Steep Turns

At a constant altitude, during a coordinated turn in any aircraft, the load factor is the result of two forces: centrifugal force and weight. [Figure 5-52] For any given bank angle, the ROT varies with the airspeed—the higher the speed, the

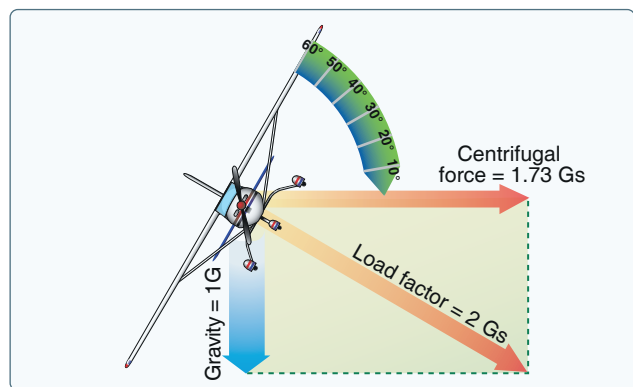

Figure 5-52. Two forces cause load factor during turns.

slower the ROT. This compensates for added centrifugal force, allowing the load factor to remain the same.

Figure 5-53 reveals an important fact about turns—the load factor increases at a terrific rate after a bank has reached 45° or 50°. The load factor for any aircraft in a coordinated level turn at 60° bank is 2 Gs. The load factor in an 80° bank is 5.76 Gs. The wing must produce lift equal to these load factors if altitude is to be maintained.

It should be noted how rapidly the line denoting load factor rises as it approaches the 90° bank line, which it never quite reaches because a 90° banked, constant altitude turn is not mathematically possible. An aircraft may be banked to 90° in a coordinated turn if not trying to hold altitude. An aircraft that can be held in a 90° banked slipping turn is capable of straight knife-edged flight. At slightly more than 80°, the load factor exceeds the limit of 6 Gs, the limit load factor of an acrobatic aircraft.

For a coordinated, constant altitude turn, the approximate maximum bank for the average general aviation aircraft is 60°. This bank and its resultant necessary power setting reach the limit of this type of aircraft. An additional 10° bank increases the load factor by approximately 1 G, bringing it close to the yield point established for these aircraft. [Figure 5-54]

### Load Factors and Stalling Speeds

Any aircraft, within the limits of its structure, may be stalled at any airspeed. When a sufficiently high AOA is imposed, the smooth flow of air over an airfoil breaks up and separates, producing an abrupt change of flight characteristics and a sudden loss of lift, which results in a stall.

A study of this effect has revealed that an aircraft's stalling speed increases in proportion to the square root of the

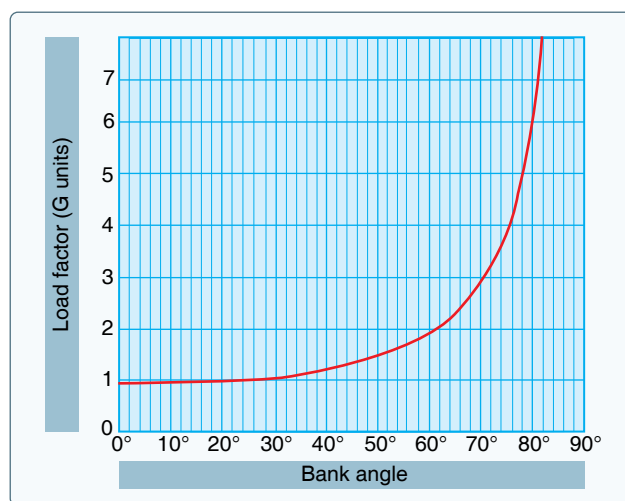

Figure 5-53. Angle of bank changes load factor in level flight.

load factor. This means that an aircraft with a normal unaccelerated stalling speed of 50 knots can be stalled at 100 knots by inducing a load factor of 4 Gs. If it were possible for this aircraft to withstand a load factor of nine, it could be stalled at a speed of 150 knots. A pilot should be aware of the following:

- The danger of inadvertently stalling the aircraft by increasing the load factor, as in a steep turn or spiral;
- When intentionally stalling an aircraft above its design maneuvering speed, a tremendous load factor is imposed.

Figures 5-53 and 5-54 show that banking an aircraft greater than 72° in a steep turn produces a load factor of 3, and the stalling speed is increased significantly. If this turn is made in an aircraft with a normal unaccelerated stalling speed of 45 knots, the airspeed must be kept greater than 75 knots to prevent inducing a stall. A similar effect is experienced in a quick pull up or any maneuver producing load factors above 1 G. This sudden, unexpected loss of control, particularly in a steep turn or abrupt application of the back elevator control near the ground, has caused many accidents.

Since the load factor is squared as the stalling speed doubles, tremendous loads may be imposed on structures by stalling an aircraft at relatively high airspeeds.

The following information primarily applies to fixed-wing airplanes. The maximum speed at which an airplane may be stalled safely is now determined for all new designs.

This speed is called the “design maneuvering speed” ( $V_A$ ), which is the speed below which you can move a single flight control, one time, to its full deflection, for one axis of airplane rotation only (pitch, roll or yaw), in smooth air, without risk of damage to the airplane.  $V_A$  must be entered in the FAA-approved Airplane Flight Manual/ Pilot’s Operating Handbook (AFM/POH) of all recently designed airplanes. For older general aviation airplanes, this speed is approximately 1.7 times the normal stalling speed. Thus, an older airplane that normally stalls at 60 knots must never be stalled at above 102 knots ( $60 \text{ knots} \times 1.7 = 102 \text{ knots}$ ). An airplane with a normal stalling speed of 60 knots stalled at 102 knots undergoes a load factor equal to the square of the increase in speed, or 2.89 Gs ( $1.7 \times 1.7 = 2.89 \text{ Gs}$ ). (The above figures are approximations to be considered as a guide, and are not the exact answers to any set of problems. The design maneuvering speed should be determined from the particular airplane’s operating limitations provided by the manufacturer.) Operating at or below design maneuvering speed does not provide structural protection against multiple full control inputs in one axis or full control inputs in more than one axis at the same time.

Since the leverage in the control system varies with different aircraft (some types employ “balanced” control surfaces while others do not), the pressure exerted by the pilot on the controls cannot be accepted as an index of the load factors produced in different aircraft. In most cases, load factors can be judged by the experienced pilot from the feel of seat pressure. Load factors can also be measured by an instrument called an “accelerometer,” but this instrument is not common in general

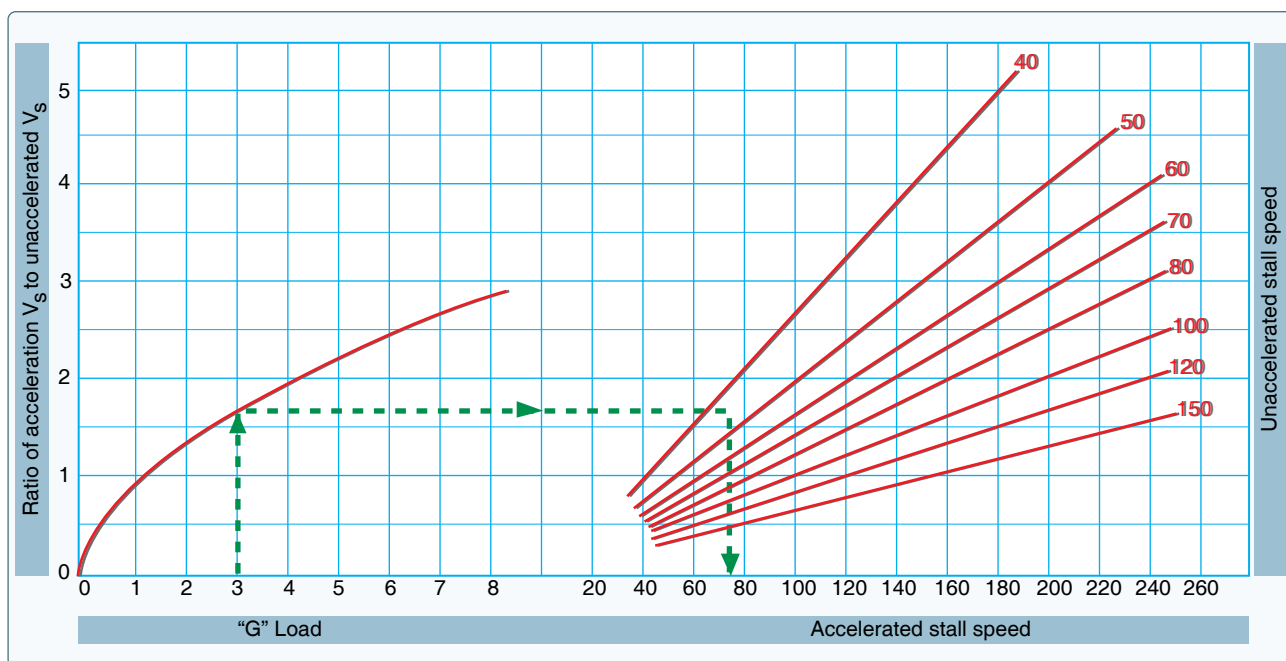

Figure 5-54. Load factor changes stall speed.

aviation training aircraft. The development of the ability to judge load factors from the feel of their effect on the body is important. A knowledge of these principles is essential to the development of the ability to estimate load factors.

A thorough knowledge of load factors induced by varying degrees of bank and the  $V_A$  aids in the prevention of two of the most serious types of accidents:

1. Stalls from steep turns or excessive maneuvering near the ground
2. Structural failures during acrobatics or other violent maneuvers resulting from loss of control

### **Load Factors and Flight Maneuvers**

Critical load factors apply to all flight maneuvers except unaccelerated straight flight where a load factor of 1 G is always present. Certain maneuvers considered in this section are known to involve relatively high load factors. Full application of pitch, roll, or yaw controls should be confined to speeds below the maneuvering speed. Avoid rapid and large alternating control inputs, especially in combination with large changes in pitch, roll, or yaw (e.g., large sideslip angles) as they may result in structural failures at any speed, including below  $V_A$ .

#### ***Turns***

Increased load factors are a characteristic of all banked turns. As noted in the section on load factors in steep turns, load factors become significant to both flight performance and load on wing structure as the bank increases beyond approximately  $45^\circ$ .

The yield factor of the average light plane is reached at a bank of approximately  $70^\circ$  to  $75^\circ$ , and the stalling speed is increased by approximately one-half at a bank of approximately  $63^\circ$ .

#### ***Stalls***

The normal stall entered from straight-and-level flight, or an unaccelerated straight climb, does not produce added load factors beyond the 1 G of straight-and-level flight. As the stall occurs, however, this load factor may be reduced toward zero, the factor at which nothing seems to have weight. The pilot experiences a sensation of "floating free in space." If recovery is effected by snapping the elevator control forward, negative load factors (or those that impose a down load on the wings and raise the pilot from the seat) may be produced.

During the pull up following stall recovery, significant load factors are sometimes induced. These may be further increased inadvertently during excessive diving (and consequently high airspeed) and abrupt pull ups to level flight. One usually leads to the other, thus increasing the load

factor. Abrupt pull ups at high diving speeds may impose critical loads on aircraft structures and may produce recurrent or secondary stalls by increasing the AOA to that of stalling.

As a generalization, a recovery from a stall made by diving only to cruising or design maneuvering airspeed, with a gradual pull up as soon as the airspeed is safely above stalling, can be effected with a load factor not to exceed 2 or 2.5 Gs. A higher load factor should never be necessary unless recovery has been effected with the aircraft's nose near or beyond the vertical attitude or at extremely low altitudes to avoid diving into the ground.

#### ***Spins***

A stabilized spin is not different from a stall in any element other than rotation and the same load factor considerations apply to spin recovery as apply to stall recovery. Since spin recoveries are usually effected with the nose much lower than is common in stall recoveries, higher airspeeds and consequently higher load factors are to be expected. The load factor in a proper spin recovery usually is found to be about 2.5 Gs.

The load factor during a spin varies with the spin characteristics of each aircraft, but is usually found to be slightly above the 1 G of level flight. There are two reasons for this:

1. Airspeed in a spin is very low, usually within 2 knots of the unaccelerated stalling speeds.
2. An aircraft pivots, rather than turns, while it is in a spin.

#### ***High Speed Stalls***

The average light plane is not built to withstand the repeated application of load factors common to high speed stalls. The load factor necessary for these maneuvers produces a stress on the wings and tail structure, which does not leave a reasonable margin of safety in most light aircraft.

The only way this stall can be induced at an airspeed above normal stalling involves the imposition of an added load factor, which may be accomplished by a severe pull on the elevator control. A speed of 1.7 times stalling speed (about 102 knots in a light aircraft with a stalling speed of 60 knots) produces a load factor of 3 Gs. Only a very narrow margin for error can be allowed for acrobatics in light aircraft. To illustrate how rapidly the load factor increases with airspeed, a high-speed stall at 112 knots in the same aircraft would produce a load factor of 4 Gs.

#### ***Chandelles and Lazy Eights***

A chandelle is a maximum performance climbing turn beginning from approximately straight-and-level flight, and ending at the completion of a precise  $180^\circ$  turn in a wings-level, nose-high attitude at the minimum controllable

airspeed. In this flight maneuver, the aircraft is in a steep climbing turn and almost stalls to gain altitude while changing direction. A lazy eight derives its name from the manner in which the extended longitudinal axis of the aircraft is made to trace a flight pattern in the form of a figure “8” lying on its side. It would be difficult to make a definite statement concerning load factors in these maneuvers as both involve smooth, shallow dives and pull-ups. The load factors incurred depend directly on the speed of the dives and the abruptness of the pull-ups during these maneuvers.

Generally, the better the maneuver is performed, the less extreme the load factor induced. A chandelle or lazy eight in which the pull-up produces a load factor greater than 2 Gs will not result in as great a gain in altitude; in low-powered aircraft, it may result in a net loss of altitude.

The smoothest pull-up possible, with a moderate load factor, delivers the greatest gain in altitude in a chandelle and results in a better overall performance in both chandelles and lazy eights. The recommended entry speed for these maneuvers is generally near the manufacturer’s design maneuvering speed, which allows maximum development of load factors without exceeding the load limits.

### **Rough Air**

All standard certificated aircraft are designed to withstand loads imposed by gusts of considerable intensity. Gust load factors increase with increasing airspeed, and the strength used for design purposes usually corresponds to the highest level flight speed. In extremely rough air, as in thunderstorms or frontal conditions, it is wise to reduce the speed to the design maneuvering speed. Regardless of the speed held, there may be gusts that can produce loads that exceed the load limits.

Each specific aircraft is designed with a specific G loading that can be imposed on the aircraft without causing structural damage. There are two types of load factors factored into aircraft design: limit load and ultimate load. The limit load is a force applied to an aircraft that causes a bending of the aircraft structure that does not return to the original shape. The ultimate load is the load factor applied to the aircraft beyond the limit load and at which point the aircraft material experiences structural failure (breakage). Load factors lower than the limit load can be sustained without compromising the integrity of the aircraft structure.

Speeds up to, but not exceeding, the maneuvering speed allow an aircraft to stall prior to experiencing an increase in load factor that would exceed the limit load of the aircraft.

Most AFM/POH now include turbulent air penetration information, which help today’s pilots safely fly aircraft

capable of a wide range of speeds and altitudes. It is important for the pilot to remember that the maximum “never-exceed” placard dive speeds are determined for smooth air only. High speed dives or acrobatics involving speed above the known maneuvering speed should never be practiced in rough or turbulent air.

### **Vg Diagram**

The flight operating strength of an aircraft is presented on a graph whose vertical scale is based on load factor. [Figure 5-55] The diagram is called a Vg diagram—velocity versus G loads or load factor. Each aircraft has its own Vg diagram that is valid at a certain weight and altitude.

The lines of maximum lift capability (curved lines) are the first items of importance on the Vg diagram. The aircraft in *Figure 5-53* is capable of developing no more than +1 G at 64 mph, the wing level stall speed of the aircraft. Since the maximum load factor varies with the square of the airspeed, the maximum positive lift capability of this aircraft is 2 G at 92 mph, 3 G at 112 mph, 4.4 G at 137 mph, and so forth. Any load factor above this line is unavailable aerodynamically (i.e., the aircraft cannot fly above the line of maximum lift capability because it stalls). The same situation exists for negative lift flight with the exception that the speed necessary to produce a given negative load factor is higher than that to produce the same positive load factor.

If the aircraft is flown at a positive load factor greater than the positive limit load factor of 4.4, structural damage is possible. When the aircraft is operated in this region, objectionable permanent deformation of the primary structure may take place and a high rate of fatigue damage is incurred. Operation above the limit load factor must be avoided in normal operation.

There are two other points of importance on the Vg diagram. One point is the intersection of the positive limit load factor and the line of maximum positive lift capability. The airspeed at this point is the minimum airspeed at which the limit load can be developed aerodynamically. Any airspeed greater than this provides a positive lift capability sufficient to damage the aircraft. Conversely, any airspeed less than this does not provide positive lift capability sufficient to cause damage from excessive flight loads. The usual term given to this speed is “maneuvering speed,” since consideration of subsonic aerodynamics would predict minimum usable turn radius or maneuverability to occur at this condition. The maneuver speed is a valuable reference point, since an aircraft operating below this point cannot produce a damaging positive flight load. Any combination of maneuver and gust cannot create damage due to excess airload when the aircraft is below the maneuver speed.

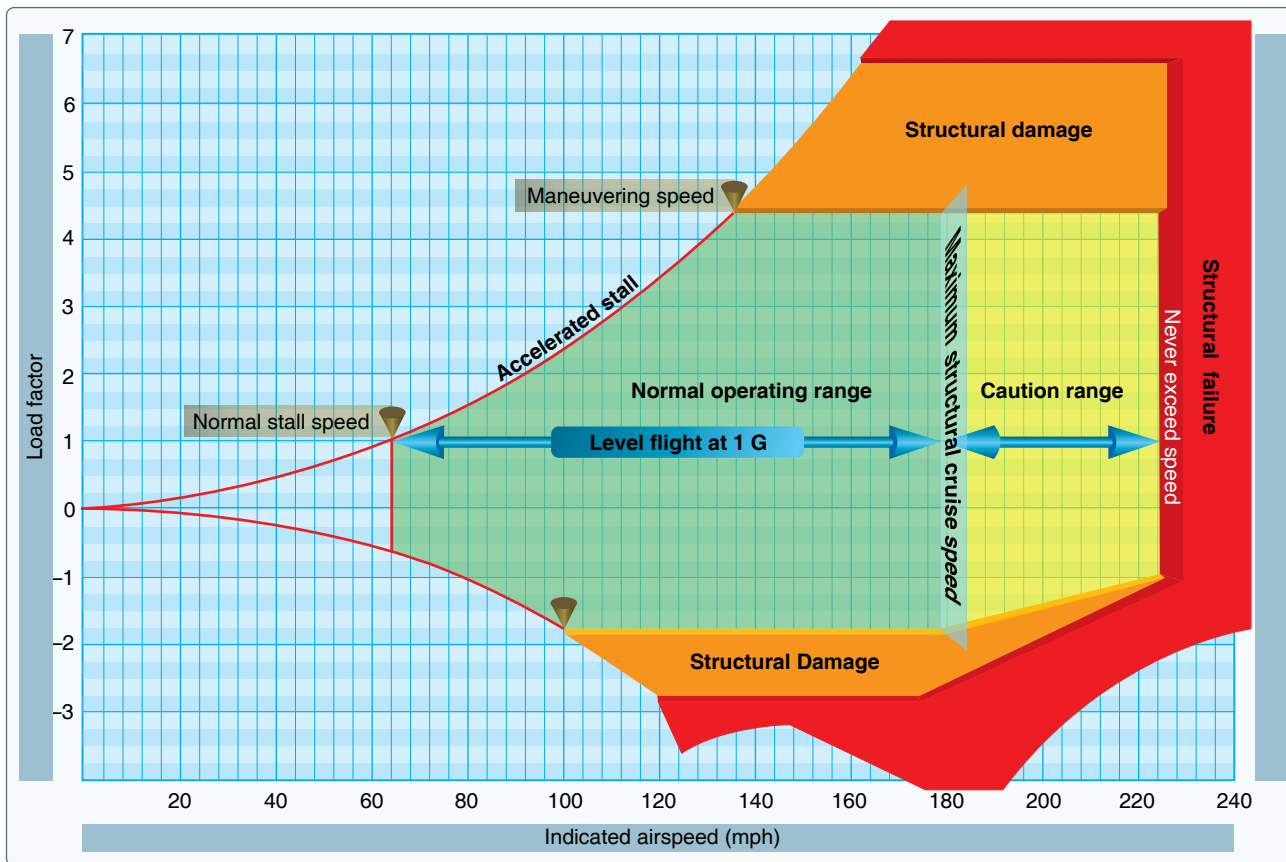

Figure 5-55. Typical  $V_g$  diagram.

The other point of importance on the  $V_g$  diagram is the intersection of the negative limit load factor and line of maximum negative lift capability. Any airspeed greater than this provides a negative lift capability sufficient to damage the aircraft; any airspeed less than this does not provide negative lift capability sufficient to damage the aircraft from excessive flight loads.

The limit airspeed (or redline speed) is a design reference point for the aircraft—this aircraft is limited to 225 mph. If flight is attempted beyond the limit airspeed, structural damage or structural failure may result from a variety of phenomena.

The aircraft in flight is limited to a regime of airspeeds and Gs that do not exceed the limit (or redline) speed, do not exceed the limit load factor, and cannot exceed the maximum lift capability. The aircraft must be operated within this “envelope” to prevent structural damage and ensure the anticipated service lift of the aircraft is obtained. The pilot must appreciate the  $V_g$  diagram as describing the allowable combination of airspeeds and load factors for safe operation. Any maneuver, gust, or gust plus maneuver outside the structural envelope can cause structural damage and effectively shorten the service life of the aircraft.

### Rate of Turn

The rate of turn (ROT) is the number of degrees (expressed in degrees per second) of heading change that an aircraft makes. The ROT can be determined by taking the constant of 1,091, multiplying it by the tangent of any bank angle and dividing that product by a given airspeed in knots as illustrated in *Figure 5-55*. If the airspeed is increased and the ROT desired is to be constant, the angle of bank must be increased, otherwise, the ROT decreases. Likewise, if the airspeed is held constant, an aircraft’s ROT increases if the bank angle is increased. The formula in *Figures 5-56* through *5-58* depicts the relationship between bank angle and airspeed as they affect the ROT.

NOTE: All airspeed discussed in this section is true airspeed (TAS).

Airspeed significantly effects an aircraft’s ROT. If airspeed is increased, the ROT is reduced if using the same angle of bank used at the lower speed. Therefore, if airspeed is increased as illustrated in *Figure 5-57*, it can be inferred that the angle of bank must be increased in order to achieve the same ROT achieved in *Figure 5-58*.

$$\text{ROT} = \frac{1,091 \times \text{tangent of the bank angle}}{\text{airspeed (in knots)}}$$

**Example** The rate of turn for an aircraft in a coordinated turn of 30° and traveling at 120 knots would have a ROT as follows.

$$\text{ROT} = \frac{1,091 \times \text{tangent of } 30^\circ}{120 \text{ knots}}$$

$$\text{ROT} = \frac{1,091 \times 0.5773 \text{ (tangent of } 30^\circ)}{120 \text{ knots}}$$

$$\text{ROT} = 5.25 \text{ degrees per second}$$

**Figure 5-56.** Rate of turn for a given airspeed (knots, TAS) and bank angle.

What does this mean on a practicable side? If a given airspeed and bank angle produces a specific ROT, additional conclusions can be made. Knowing the ROT is a given number of degrees of change per second, the number of seconds it takes to travel 360° (a circle) can be determined by simple division. For example, if moving at 120 knots with a 30° bank angle, the ROT is 5.25° per second and it takes 68.6 seconds (360° divided by 5.25 = 68.6 seconds) to make a complete circle. Likewise, if flying at 240 knots TAS and using a 30° angle of bank, the ROT is only about 2.63° per second and it takes about 137 seconds to complete a 360° circle. Looking at the formula, any increase in airspeed is directly proportional to the time the aircraft takes to travel an arc.

So why is this important to understand? Once the ROT is understood, a pilot can determine the distance required to make that particular turn, which is explained in radius of turn.

### Radius of Turn

The radius of turn is directly linked to the ROT, which explained earlier is a function of both bank angle and airspeed. If the bank angle is held constant and the airspeed is increased, the radius of the turn changes (increases). A higher airspeed causes the aircraft to travel through a longer

**Example** Suppose we were to increase the speed to 240 knots, what is the ROT? Using the same formula from above we see that:

$$\text{ROT} = \frac{1,091 \times \text{tangent of } 30^\circ}{240 \text{ knots}}$$

$$\text{ROT} = 2.62 \text{ degrees per second}$$

An increase in speed causes a decrease in the ROT when using the same bank angle.

**Figure 5-57.** Rate of turn when increasing speed.

**Example** Suppose we wanted to know what bank angle would give us a rate of turn of 5.25° per second at 240 knots. A slight rearrangement of the formula would indicate it will take a 49° angle of bank to achieve the same ROT used at the lower airspeed of 120 knots.

$$\text{ROT (5.25)} = \frac{1,091 \times \text{tangent of } X}{240 \text{ knots}}$$

$$240 \times 5.25 = 1,091 \times \text{tangent of } X$$

$$\frac{240 \times 5.25}{1,091} = \text{tangent of } X$$

$$1.1549 = \text{tangent of } X$$

$$49^\circ = X$$

**Figure 5-58.** To achieve the same rate of turn of an aircraft traveling at 120 knots, an increase of bank angle is required.

arc due to a greater speed. An aircraft traveling at 120 knots is able to turn a 360° circle in a tighter radius than an aircraft traveling at 240 knots. In order to compensate for the increase in airspeed, the bank angle would need to be increased.

The radius of turn (R) can be computed using a simple formula. The radius of turn is equal to the velocity squared (V<sup>2</sup>) divided by 11.26 times the tangent of the bank angle.

$$R = \frac{V^2}{11.26 \times \text{tangent of bank angle}}$$

Using the examples provided in Figures 5-56 through 5-58, the turn radius for each of the two speeds can be computed.

Note that if the speed is doubled, the radius is quadrupled. [Figures 5-59 and 5-60]

Another way to determine the radius of turn is speed using feet per second (fps), π (3.1415), and the ROT. In one of the previous examples, it was determined that an aircraft with a ROT of 5.25 degrees per second required 68.6 seconds to make a complete circle. An aircraft's speed (in knots) can

**120 knots**

$$R = \frac{V^2}{11.26 \times \text{tangent of bank angle}}$$

$$R = \frac{120^2}{11.26 \times \text{tangent of } 30^\circ}$$

$$R = \frac{14,400}{11.26 \times 0.5773}$$

$$R = 2,215 \text{ feet}$$

The radius of a turn required by an aircraft traveling at 120 knots and using a bank angle of 30° is 2,215 feet

**Figure 5-59.** Radius at 120 knots with bank angle of 30°.

240 knots	$R = \frac{V^2}{11.26 \times \text{tangent of bank angle}}$ $R = \frac{240^2}{11.26 \times \text{tangent of } 30^\circ}$ $R = \frac{57,600}{11.26 \times 0.57735}$ $R = 8,861 \text{ feet}$ <p style="text-align: center;">(four times the radius at 120 knots)</p> <p>The radius of a turn required by an aircraft traveling at 240 knots using the same bank angle in Figure 4-51 is 8,861 feet. Speed is a major factor in a turn.</p>
-----------	---

**Figure 5-60.** Radius at 240 knots.

be converted to fps by multiplying it by a constant of 1.69. Therefore, an aircraft traveling at 120 knots (TAS) travels at 202.8 fps. Knowing the speed in fps (202.8) multiplied by the time an aircraft takes to complete a circle (68.6 seconds) can determine the size of the circle; 202.8 times 68.6 equals 13,912 feet. Dividing by  $\pi$  yields a diameter of 4,428 feet, which when divided by 2 equals a radius of 2,214 feet [Figure 5-61], a foot within that determined through use of the formula in Figure 5-59.

In Figure 5-62, the pilot enters a canyon and decides to turn 180° to exit. The pilot uses a 30° bank angle in his turn.

## Weight and Balance

The aircraft’s weight and balance data is important information for a pilot that must be frequently reevaluated. Although the aircraft was weighed during the certification process, this information is not valid indefinitely. Equipment changes or modifications affect the weight and balance data. Too often pilots reduce the aircraft weight and balance into a rule of thumb, such as: “If I have three passengers, I can load only 100 gallons of fuel; four passengers, 70 gallons.”

Weight and balance computations should be part of every preflight briefing. Never assume three passengers are always

$r = \frac{\text{speed (fps)} \times \frac{360}{\text{ROT}}}{\frac{\text{Pi } (\pi)}{2}}$ $r = \frac{202.8 \times 68.6}{\frac{\pi}{2}}$ $r = \frac{13,912}{\frac{\pi}{2}}$ $r = \frac{4,428}{2} = 2,214 \text{ feet}$
---

**Figure 5-61.** Another formula that can be used for radius.

of equal weight. Instead, do a full computation of all items to be loaded on the aircraft, including baggage, as well as the pilot and passenger. It is recommended that all bags be weighed to make a precise computation of how the aircraft CG is positioned.

The importance of the CG was stressed in the discussion of stability, controllability, and performance. Unequal load distribution causes accidents. A competent pilot understands and respects the effects of CG on an aircraft.

Weight and balance are critical components in the utilization of an aircraft to its fullest potential. The pilot must know how much fuel can be loaded onto the aircraft without violating CG limits, as well as weight limits to conduct long or short flights with or without a full complement of allowable passengers. For example, an aircraft has four seats and can carry 60 gallons of fuel. How many passengers can the aircraft safely carry? Can all those seats be occupied at all times with the varying fuel loads? Four people who each weigh 150 pounds leads to a different weight and balance computation than four people who each weigh 200 pounds. The second scenario loads an additional 200 pounds onto the aircraft and is equal to about 30 gallons of fuel.

The additional weight may or may not place the CG outside of the CG envelope, but the maximum gross weight could be exceeded. The excess weight can overstress the aircraft and degrade the performance.

Aircraft are certificated for weight and balance for two principal reasons:

1. The effect of the weight on the aircraft’s primary structure and its performance characteristics
2. The effect of the location of this weight on flight characteristics, particularly in stall and spin recovery and stability

Aircraft, such as balloons and weight-shift control, do not require weight and balance computations because the load is suspended below the lifting mechanism. The CG range in these types of aircraft is such that it is difficult to exceed loading limits. For example, the rear seat position and fuel of a weight-shift control aircraft are as close as possible to the hang point with the aircraft in a suspended attitude. Thus, load variations have little effect on the CG. This also holds true for the balloon basket or gondola. While it is difficult to exceed CG limits in these aircraft, pilots should never overload an aircraft because overloading causes structural damage and failures. Weight and balance computations are not required, but pilots should calculate weight and remain within the manufacturer’s established limit.



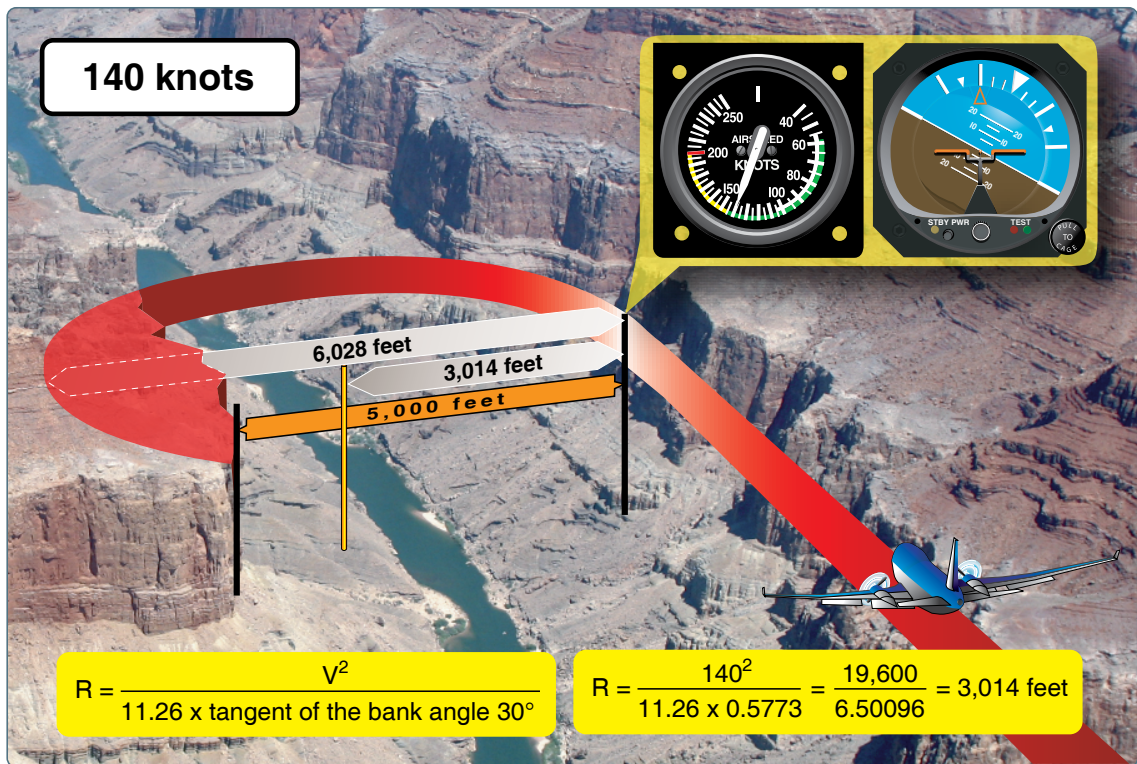
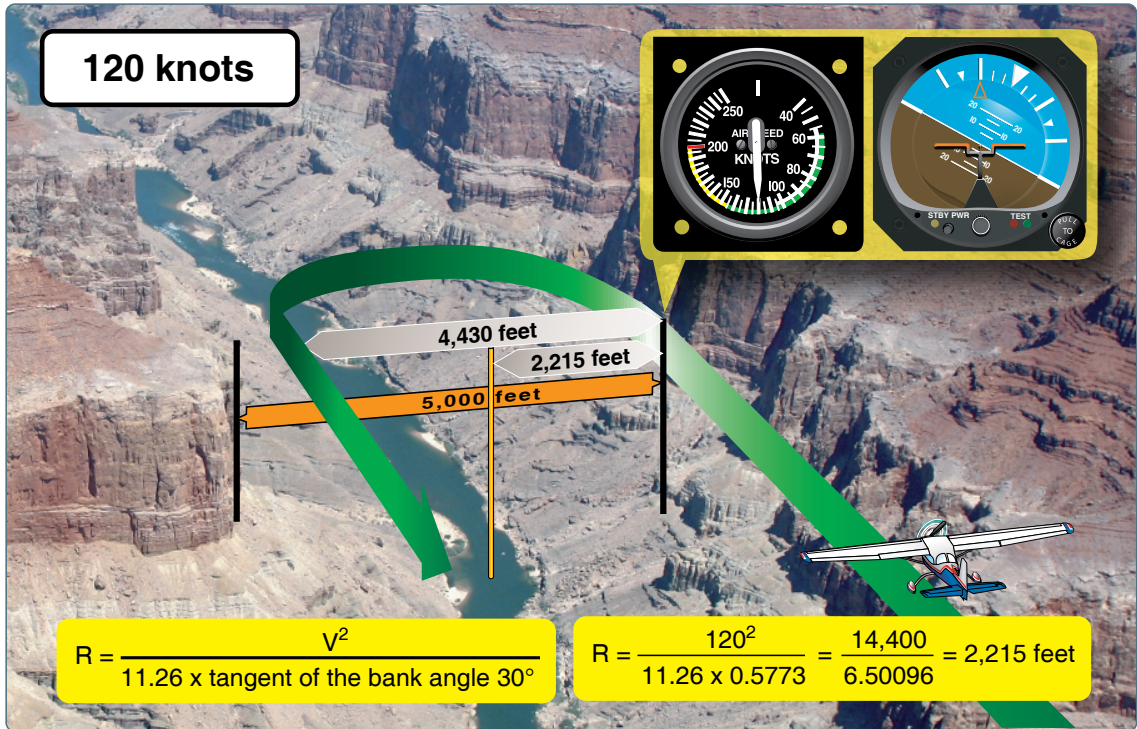

**Figure 5-62.** Two aircraft have flown into a canyon by error. The canyon is 5,000 feet across and has sheer cliffs on both sides. The pilot in the top image is flying at 120 knots. After realizing the error, the pilot banks hard and uses a 30° bank angle to reverse course. This aircraft requires about 4,000 feet to turn 180°, and makes it out of the canyon safely. The pilot in the bottom image is flying at 140 knots and also uses a 30° angle of bank in an attempt to reverse course. The aircraft, although flying just 20 knots faster than the aircraft in the top image, requires over 6,000 feet to reverse course to safety. Unfortunately, the canyon is only 5,000 feet across and the aircraft will hit the canyon wall. The point is that airspeed is the most influential factor in determining how much distance is required to turn. Many pilots have made the error of increasing the steepness of their bank angle when a simple reduction of speed would have been more appropriate.

## **Effect of Weight on Flight Performance**

The takeoff/climb and landing performance of an aircraft are determined on the basis of its maximum allowable takeoff and landing weights. A heavier gross weight results in a longer takeoff run and shallower climb, and a faster touchdown speed and longer landing roll. Even a minor overload may make it impossible for the aircraft to clear an obstacle that normally would not be a problem during takeoff under more favorable conditions.

The detrimental effects of overloading on performance are not limited to the immediate hazards involved with takeoffs and landings. Overloading has an adverse effect on all climb and cruise performance, which leads to overheating during climbs, added wear on engine parts, increased fuel consumption, slower cruising speeds, and reduced range.

The manufacturers of modern aircraft furnish weight and balance data with each aircraft produced. Generally, this information may be found in the FAA-approved AFM/POH and easy-to-read charts for determining weight and balance data are now provided. Increased performance and load-carrying capability of these aircraft require strict adherence to the operating limitations prescribed by the manufacturer. Deviations from the recommendations can result in structural damage or complete failure of the aircraft's structure. Even if an aircraft is loaded well within the maximum weight limitations, it is imperative that weight distribution be within the limits of CG location. The preceding brief study of aerodynamics and load factors points out the reasons for this precaution. The following discussion is background information into some of the reasons why weight and balance conditions are important to the safe flight of an aircraft.

In some aircraft, it is not possible to fill all seats, baggage compartments, and fuel tanks, and still remain within approved weight or balance limits. For example, in several popular four-place aircraft, the fuel tanks may not be filled to capacity when four occupants and their baggage are carried. In a certain two-place aircraft, no baggage may be carried in the compartment aft of the seats when spins are to be practiced. It is important for a pilot to be aware of the weight and balance limitations of the aircraft being flown and the reasons for these limitations.

## **Effect of Weight on Aircraft Structure**

The effect of additional weight on the wing structure of an aircraft is not readily apparent. Airworthiness requirements prescribe that the structure of an aircraft certificated in the normal category (in which acrobatics are prohibited) must be strong enough to withstand a load factor of 3.8 Gs to take care of dynamic loads caused by maneuvering and gusts. This means that the primary structure of the aircraft can withstand

a load of 3.8 times the approved gross weight of the aircraft without structural failure occurring. If this is accepted as indicative of the load factors that may be imposed during operations for which the aircraft is intended, a 100-pound overload imposes a potential structural overload of 380 pounds. The same consideration is even more impressive in the case of utility and acrobatic category aircraft, which have load factor requirements of 4.4 and 6.0, respectively.

Structural failures that result from overloading may be dramatic and catastrophic, but more often they affect structural components progressively in a manner that is difficult to detect and expensive to repair. Habitual overloading tends to cause cumulative stress and damage that may not be detected during preflight inspections and result in structural failure later during completely normal operations. The additional stress placed on structural parts by overloading is believed to accelerate the occurrence of metallic fatigue failures.

A knowledge of load factors imposed by flight maneuvers and gusts emphasizes the consequences of an increase in the gross weight of an aircraft. The structure of an aircraft about to undergo a load factor of 3 Gs, as in recovery from a steep dive, must be prepared to withstand an added load of 300 pounds for each 100-pound increase in weight. It should be noted that this would be imposed by the addition of about 16 gallons of unneeded fuel in a particular aircraft. FAA-certificated civil aircraft have been analyzed structurally and tested for flight at the maximum gross weight authorized and within the speeds posted for the type of flights to be performed. Flights at weights in excess of this amount are quite possible and often are well within the performance capabilities of an aircraft. This fact should not mislead the pilot, as the pilot may not realize that loads for which the aircraft was not designed are being imposed on all or some part of the structure.

In loading an aircraft with either passengers or cargo, the structure must be considered. Seats, baggage compartments, and cabin floors are designed for a certain load or concentration of load and no more. For example, a light plane baggage compartment may be placarded for 20 pounds because of the limited strength of its supporting structure even though the aircraft may not be overloaded or out of CG limits with more weight at that location.

## **Effect of Weight on Stability and Controllability**

Overloading also affects stability. An aircraft that is stable and controllable when loaded normally may have very different flight characteristics when overloaded. Although the distribution of weight has the most direct effect on this, an increase in the aircraft's gross weight may be expected to have an adverse effect on stability, regardless of location

of the CG. The stability of many certificated aircraft is completely unsatisfactory if the gross weight is exceeded.

### Effect of Load Distribution

The effect of the position of the CG on the load imposed on an aircraft's wing in flight is significant to climb and cruising performance. An aircraft with forward loading is "heavier" and consequently, slower than the same aircraft with the CG further aft.

*Figure 5-63* illustrates why this is true. With forward loading, "nose-up" trim is required in most aircraft to maintain level cruising flight. Nose-up trim involves setting the tail surfaces to produce a greater down load on the aft portion of the fuselage, which adds to the wing loading and the total lift required from the wing if altitude is to be maintained. This requires a higher AOA of the wing, which results in more drag and, in turn, produces a higher stalling speed.

With aft loading and "nose-down" trim, the tail surfaces exert less down load, relieving the wing of that much wing loading and lift required to maintain altitude. The required AOA of the wing is less, so the drag is less, allowing for a faster cruise speed. Theoretically, a neutral load on the tail surfaces in cruising flight would produce the most efficient overall performance and fastest cruising speed, but it would also result in instability. Modern aircraft are designed to require a down load on the tail for stability and controllability. A zero indication on the trim tab control is not necessarily the same as "neutral trim" because of the force exerted by downwash from the wings and the fuselage on the tail surfaces.

The effects of the distribution of the aircraft's useful load have a significant influence on its flight characteristics, even when the load is within the CG limits and the maximum

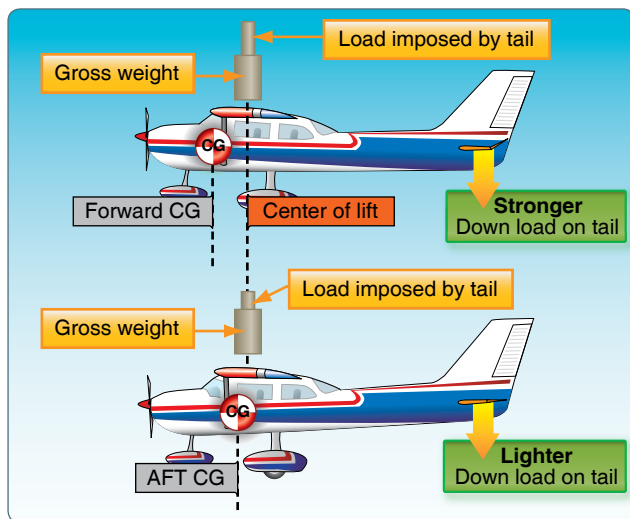

**Figure 5-63.** *Effect of load distribution on balance.*

permissible gross weight. Important among these effects are changes in controllability, stability, and the actual load imposed on the wing.

Generally, an aircraft becomes less controllable, especially at slow flight speeds, as the CG is moved further aft. An aircraft that cleanly recovers from a prolonged spin with the CG at one position may fail completely to respond to normal recovery attempts when the CG is moved aft by one or two inches.

It is common practice for aircraft designers to establish an aft CG limit that is within one inch of the maximum, which allows normal recovery from a one-turn spin. When certificating an aircraft in the utility category to permit intentional spins, the aft CG limit is usually established at a point several inches forward of that permissible for certification in the normal category.

Another factor affecting controllability, which has become more important in current designs of large aircraft, is the effect of long moment arms to the positions of heavy equipment and cargo. The same aircraft may be loaded to maximum gross weight within its CG limits by concentrating fuel, passengers, and cargo near the design CG, or by dispersing fuel and cargo loads in wingtip tanks and cargo bins forward and aft of the cabin.

With the same total weight and CG, maneuvering the aircraft or maintaining level flight in turbulent air requires the application of greater control forces when the load is dispersed. The longer moment arms to the positions of the heavy fuel and cargo loads must be overcome by the action of the control surfaces. An aircraft with full outboard wing tanks or tip tanks tends to be sluggish in roll when control situations are marginal, while one with full nose and aft cargo bins tends to be less responsive to the elevator controls.

The rearward CG limit of an aircraft is determined largely by considerations of stability. The original airworthiness requirements for a type certificate specify that an aircraft in flight at a certain speed dampens out vertical displacement of the nose within a certain number of oscillations. An aircraft loaded too far rearward may not do this. Instead, when the nose is momentarily pulled up, it may alternately climb and dive becoming steeper with each oscillation. This instability is not only uncomfortable to occupants, but it could even become dangerous by making the aircraft unmanageable under certain conditions.

The recovery from a stall in any aircraft becomes progressively more difficult as its CG moves aft. This is particularly important in spin recovery, as there is a point in rearward

loading of any aircraft at which a “flat” spin develops. A flat spin is one in which centrifugal force, acting through a CG located well to the rear, pulls the tail of the aircraft out away from the axis of the spin, making it impossible to get the nose down and recover.

An aircraft loaded to the rear limit of its permissible CG range handles differently in turns and stall maneuvers and has different landing characteristics than when it is loaded near the forward limit.

The forward CG limit is determined by a number of considerations. As a safety measure, it is required that the trimming device, whether tab or adjustable stabilizer, be capable of holding the aircraft in a normal glide with the power off. A conventional aircraft must be capable of a full stall, power-off landing in order to ensure minimum landing speed in emergencies. A tailwheel-type aircraft loaded excessively nose-heavy is difficult to taxi, particularly in high winds. It can be nosed over easily by use of the brakes, and it is difficult to land without bouncing since it tends to pitch down on the wheels as it is slowed down and flared for landing. Steering difficulties on the ground may occur in nosewheel-type aircraft, particularly during the landing roll and takeoff. The effects of load distribution are summarized as follows:

- The CG position influences the lift and AOA of the wing, the amount and direction of force on the tail, and the degree of deflection of the stabilizer needed to supply the proper tail force for equilibrium. The latter is very important because of its relationship to elevator control force.
- The aircraft stalls at a higher speed with a forward CG location. This is because the stalling AOA is reached at a higher speed due to increased wing loading.
- Higher elevator control forces normally exist with a forward CG location due to the increased stabilizer deflection required to balance the aircraft.
- The aircraft cruises faster with an aft CG location because of reduced drag. The drag is reduced because a smaller AOA and less downward deflection of the stabilizer are required to support the aircraft and overcome the nose-down pitching tendency.
- The aircraft becomes less stable as the CG is moved rearward. This is because when the CG is moved rearward, it causes a decrease in the AOA. Therefore, the wing contribution to the aircraft’s stability is now decreased, while the tail contribution is still stabilizing. When the point is reached that the wing and tail contributions balance, then neutral stability exists. Any CG movement further aft results in an unstable aircraft.

- A forward CG location increases the need for greater back elevator pressure. The elevator may no longer be able to oppose any increase in nose-down pitching. Adequate elevator control is needed to control the aircraft throughout the airspeed range down to the stall.

A detailed discussion and additional information relating to weight and balance can be found in Chapter 10, Weight and Balance.

## High Speed Flight

### Subsonic Versus Supersonic Flow

In subsonic aerodynamics, the theory of lift is based upon the forces generated on a body and a moving gas (air) in which it is immersed. At speeds of approximately 260 knots or less, air can be considered incompressible in that, at a fixed altitude, its density remains nearly constant while its pressure varies. Under this assumption, air acts the same as water and is classified as a fluid. Subsonic aerodynamic theory also assumes the effects of viscosity (the property of a fluid that tends to prevent motion of one part of the fluid with respect to another) are negligible and classifies air as an ideal fluid conforming to the principles of ideal-fluid aerodynamics such as continuity, Bernoulli’s principle, and circulation.

In reality, air is compressible and viscous. While the effects of these properties are negligible at low speeds, compressibility effects in particular become increasingly important as speed increases. Compressibility (and to a lesser extent viscosity) is of paramount importance at speeds approaching the speed of sound. In these speed ranges, compressibility causes a change in the density of the air around an aircraft.

During flight, a wing produces lift by accelerating the airflow over the upper surface. This accelerated air can, and does, reach sonic speeds even though the aircraft itself may be flying subsonic. At some extreme AOA, in some aircraft, the speed of the air over the top surface of the wing may be double the aircraft’s speed. It is therefore entirely possible to have both supersonic and subsonic airflow on an aircraft at the same time. When flow velocities reach sonic speeds at some location on an aircraft (such as the area of maximum camber on the wing), further acceleration results in the onset of compressibility effects, such as shock wave formation, drag increase, buffeting, stability, and control difficulties. Subsonic flow principles are invalid at all speeds above this point. *[Figure 5-64]*

### Speed Ranges

The speed of sound varies with temperature. Under standard temperature conditions of 15 °C, the speed of sound at sea level is 661 knots. At 40,000 feet, where the temperature is –55 °C, the speed of sound decreases to 574 knots. In high-

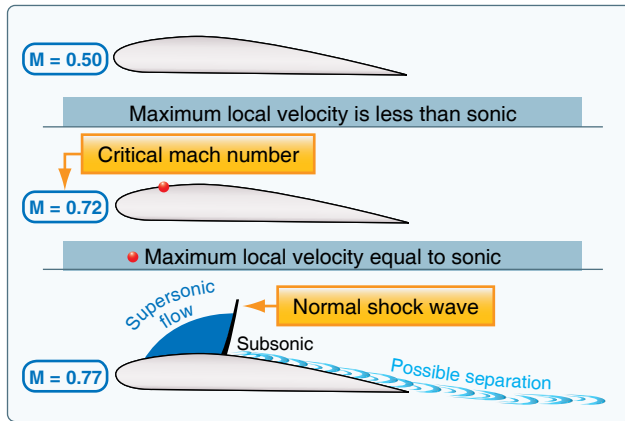

Figure 5-64. Wing airflow.

speed flight and/or high-altitude flight, the measurement of speed is expressed in terms of a “Mach number”—the ratio of the true airspeed of the aircraft to the speed of sound in the same atmospheric conditions. An aircraft traveling at the speed of sound is traveling at Mach 1.0. Aircraft speed regimes are defined approximately as follows:

- Subsonic—Mach numbers below 0.75
- Transonic—Mach numbers from 0.75 to 1.20
- Supersonic—Mach numbers from 1.20 to 5.00
- Hypersonic—Mach numbers above 5.00

While flights in the transonic and supersonic ranges are common occurrences for military aircraft, civilian jet aircraft normally operate in a cruise speed range of Mach 0.7 to Mach 0.90.

The speed of an aircraft in which airflow over any part of the aircraft or structure under consideration first reaches (but does not exceed) Mach 1.0 is termed “critical Mach number” or “Mach Crit.” Thus, critical Mach number is the boundary between subsonic and transonic flight and is largely dependent on the wing and airfoil design. Critical Mach number is an important point in transonic flight. When shock waves form on the aircraft, airflow separation followed by buffet and aircraft control difficulties can occur. Shock waves, buffet, and airflow separation take place above critical Mach number. A jet aircraft typically is most efficient when cruising at or near its critical Mach number. At speeds 5–10 percent above the critical Mach number, compressibility effects begin. Drag begins to rise sharply. Associated with the “drag rise” are buffet, trim, and stability changes and a decrease in control surface effectiveness. This is the point of “drag divergence.” [Figure 5-65]

$V_{MO}/M_{MO}$  is defined as the maximum operating limit speed.  $V_{MO}$  is expressed in knots calibrated airspeed (KCAS), while

$M_{MO}$  is expressed in Mach number. The  $V_{MO}$  limit is usually associated with operations at lower altitudes and deals with structural loads and flutter. The  $M_{MO}$  limit is associated with operations at higher altitudes and is usually more concerned with compressibility effects and flutter. At lower altitudes, structural loads and flutter are of concern; at higher altitudes, compressibility effects and flutter are of concern.

Adherence to these speeds prevents structural problems due to dynamic pressure or flutter, degradation in aircraft control response due to compressibility effects (e.g., Mach Tuck, aileron reversal, or buzz), and separated airflow due to shock waves resulting in loss of lift or vibration and buffet. Any of these phenomena could prevent the pilot from being able to adequately control the aircraft.

For example, an early civilian jet aircraft had a  $V_{MO}$  limit of 306 KCAS up to approximately FL 310 (on a standard day). At this altitude (FL 310), an  $M_{MO}$  of 0.82 was approximately equal to 306 KCAS. Above this altitude, an  $M_{MO}$  of 0.82 always equaled a KCAS less than 306 KCAS and, thus, became the operating limit as you could not reach the  $V_{MO}$  limit without first reaching the  $M_{MO}$  limit. For example, at FL 380, an  $M_{MO}$  of 0.82 is equal to 261 KCAS.

### Mach Number Versus Airspeed

It is important to understand how airspeed varies with Mach number. As an example, consider how the stall speed of a jet transport aircraft varies with an increase in altitude. The increase in altitude results in a corresponding drop in air density and outside temperature. Suppose this jet transport is in the clean configuration (gear and flaps up) and weighs 550,000 pounds. The aircraft might stall at approximately 152 KCAS at sea level. This is equal to (on a standard day) a true velocity of 152 KTAS and a Mach number of 0.23. At FL 380, the aircraft will still stall at approximately 152 KCAS, but the true velocity is about 287 KTAS with a Mach number of 0.50.

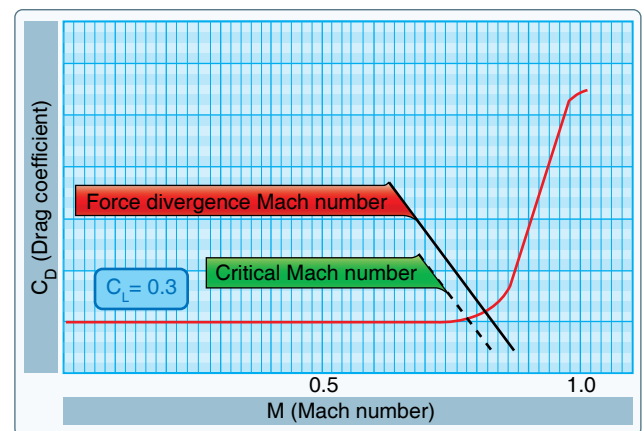

Figure 5-65. Critical Mach.

Although the stalling speed has remained the same for our purposes, both the Mach number and TAS have increased. With increasing altitude, the air density has decreased; this requires a faster true airspeed in order to have the same pressure sensed by the pitot tube for the same KCAS, or KIAS (for our purposes, KCAS and KIAS are relatively close to each other). The dynamic pressure the wing experiences at FL 380 at 287 KTAS is the same as at sea level at 152 KTAS. However, it is flying at higher Mach number.

Another factor to consider is the speed of sound. A decrease in temperature in a gas results in a decrease in the speed of sound. Thus, as the aircraft climbs in altitude with outside temperature dropping, the speed of sound is dropping. At sea level, the speed of sound is approximately 661 KCAS, while at FL 380 it is 574 KCAS. Thus, for our jet transport aircraft, the stall speed (in KTAS) has gone from 152 at sea level to 287 at FL 380. Simultaneously, the speed of sound (in KCAS) has decreased from 661 to 574 and the Mach number has increased from 0.23 (152 KTAS divided by 661 KCAS) to 0.50 (287 KTAS divided by 574 KCAS). All the while, the KCAS for stall has remained constant at 152. This describes what happens when the aircraft is at a constant KCAS with increasing altitude, but what happens when the pilot keeps Mach constant during the climb? In normal jet flight operations, the climb is at 250 KIAS (or higher (e.g. heavy)) to 10,000 feet and then at a specified en route climb airspeed (about 330 if a DC10) until reaching an altitude in the “mid-twenties” where the pilot then climbs at a constant Mach number to cruise altitude.

Assuming for illustration purposes that the pilot climbs at a  $M_{MO}$  of 0.82 from sea level up to FL 380. KCAS goes from 543 to 261. The KIAS at each altitude would follow the same behavior and just differ by a few knots. Recall from the earlier discussion that the speed of sound is decreasing with the drop in temperature as the aircraft climbs. The Mach number is simply the ratio of the true airspeed to the speed of sound at flight conditions. The significance of this is that at a constant Mach number climb, the KCAS (and KTAS or KIAS as well) is falling off.

If the aircraft climbed high enough at this constant  $M_{MO}$  with decreasing KIAS, KCAS, and KTAS, it would begin to approach its stall speed. At some point, the stall speed of the aircraft in Mach number could equal the  $M_{MO}$  of the aircraft, and the pilot could neither slow down (without stalling) nor speed up (without exceeding the max operating speed of the aircraft). This has been dubbed the “coffin corner.”

## **Boundary Layer**

The viscous nature of airflow reduces the local velocities on a surface and is responsible for skin friction. As discussed

earlier in the chapter, the layer of air over the wing’s surface that is slowed down or stopped by viscosity is the boundary layer. There are two different types of boundary layer flow: laminar and turbulent.

### ***Laminar Boundary Layer Flow***

The laminar boundary layer is a very smooth flow, while the turbulent boundary layer contains swirls or eddies. The laminar flow creates less skin friction drag than the turbulent flow but is less stable. Boundary layer flow over a wing surface begins as a smooth laminar flow. As the flow continues back from the leading edge, the laminar boundary layer increases in thickness.

### ***Turbulent Boundary Layer Flow***

At some distance back from the leading edge, the smooth laminar flow breaks down and transitions to a turbulent flow. From a drag standpoint, it is advisable to have the transition from laminar to turbulent flow as far aft on the wing as possible or have a large amount of the wing surface within the laminar portion of the boundary layer. The low energy laminar flow, however, tends to break down more suddenly than the turbulent layer.

### ***Boundary Layer Separation***

Another phenomenon associated with viscous flow is separation. Separation occurs when the airflow breaks away from an airfoil. The natural progression is from laminar boundary layer to turbulent boundary layer and then to airflow separation. Airflow separation produces high drag and ultimately destroys lift. The boundary layer separation point moves forward on the wing as the AOA is increased. [Figure 5-66]

Vortex generators are used to delay or prevent shock wave induced boundary layer separation encountered in transonic flight. They are small low aspect ratio airfoils placed at a 12° to 15° AOA to the airstream. Usually spaced a few inches apart along the wing ahead of the ailerons or other control surfaces, vortex generators create a vortex that mixes the boundary airflow with the high energy airflow just above the surface. This produces higher surface velocities and increases the energy of the boundary layer. Thus, a stronger shock wave is necessary to produce airflow separation.

### **Shock Waves**

When an airplane flies at subsonic speeds, the air ahead is “warned” of the airplane’s coming by a pressure change transmitted ahead of the airplane at the speed of sound. Because of this warning, the air begins to move aside before the airplane arrives and is prepared to let it pass easily. When the airplane’s speed reaches the speed of sound, the pressure

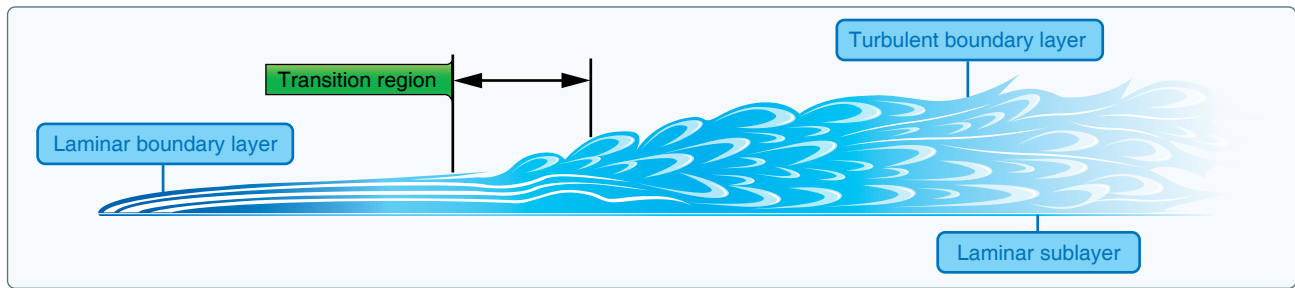

Figure 5-66. Boundary layer.

change can no longer warn the air ahead because the airplane is keeping up with its own pressure waves. Rather, the air particles pile up in front of the airplane causing a sharp decrease in the flow velocity directly in front of the airplane with a corresponding increase in air pressure and density.

As the airplane's speed increases beyond the speed of sound, the pressure and density of the compressed air ahead of it increase, the area of compression extending some distance ahead of the airplane. At some point in the airstream, the air particles are completely undisturbed, having had no advanced warning of the airplane's approach, and in the next instant the same air particles are forced to undergo sudden and drastic changes in temperature, pressure, density, and velocity. The boundary between the undisturbed air and the region of compressed air is called a shock or "compression" wave. This same type of wave is formed whenever a supersonic airstream is slowed to subsonic without a change in direction, such as when the airstream is accelerated to sonic speed over the cambered portion of a wing, and then decelerated to subsonic speed as the area of maximum camber is passed. A shock wave forms as a boundary between the supersonic and subsonic ranges.

Whenever a shock wave forms perpendicular to the airflow, it is termed a "normal" shock wave, and the flow immediately behind the wave is subsonic. A supersonic airstream passing through a normal shock wave experiences these changes:

- The airstream is slowed to subsonic.
- The airflow immediately behind the shock wave does not change direction.
- The static pressure and density of the airstream behind the wave is greatly increased.
- The energy of the airstream (indicated by total pressure—dynamic plus static) is greatly reduced.

Shock wave formation causes an increase in drag. One of the principal effects of a shock wave is the formation of a dense high pressure region immediately behind the wave. The instability of the high pressure region, and the fact that

part of the velocity energy of the airstream is converted to heat as it flows through the wave, is a contributing factor in the drag increase, but the drag resulting from airflow separation is much greater. If the shock wave is strong, the boundary layer may not have sufficient kinetic energy to withstand airflow separation. The drag incurred in the transonic region due to shock wave formation and airflow separation is known as "wave drag." When speed exceeds the critical Mach number by about 10 percent, wave drag increases sharply. A considerable increase in thrust (power) is required to increase flight speed beyond this point into the supersonic range where, depending on the airfoil shape and the AOA, the boundary layer may reattach.

Normal shock waves form on the wing's upper surface and form an additional area of supersonic flow and a normal shock wave on the lower surface. As flight speed approaches the speed of sound, the areas of supersonic flow enlarge and the shock waves move nearer the trailing edge. [Figure 5-67]

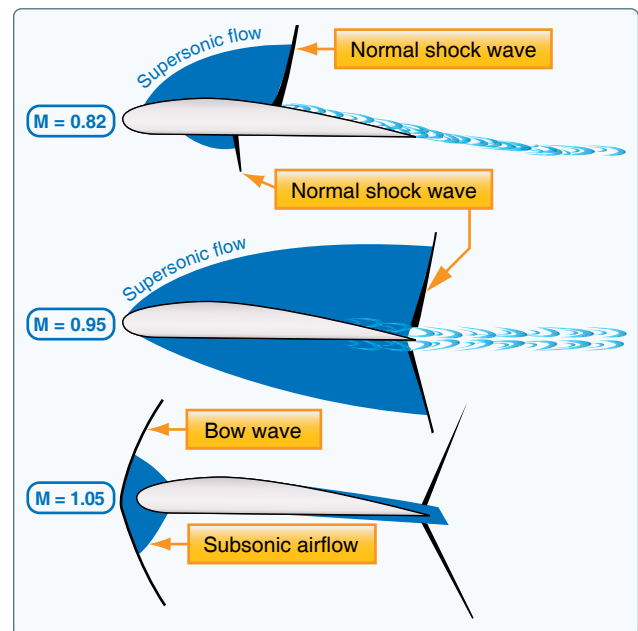

Figure 5-67. Shock waves.

Associated with “drag rise” are buffet (known as Mach buffet), trim, and stability changes and a decrease in control force effectiveness. The loss of lift due to airflow separation results in a loss of downwash and a change in the position of the center pressure on the wing. Airflow separation produces a turbulent wake behind the wing, which causes the tail surfaces to buffet (vibrate). The nose-up and nose-down pitch control provided by the horizontal tail is dependent on the downwash behind the wing. Thus, an increase in downwash decreases the horizontal tail’s pitch control effectiveness since it effectively increases the AOA that the tail surface is seeing. Movement of the wing CP affects the wing pitching moment. If the CP moves aft, a diving moment referred to as “Mach tuck” or “tuck under” is produced, and if it moves forward, a nose-up moment is produced. This is the primary reason for the development of the T-tail configuration on many turbine-powered aircraft, which places the horizontal stabilizer as far as practical from the turbulence of the wings.

### Sweepback

Most of the difficulties of transonic flight are associated with shock wave induced flow separation. Therefore, any means of delaying or alleviating the shock induced separation improves aerodynamic performance. One method is wing sweepback. Sweepback theory is based upon the concept that it is only the component of the airflow perpendicular to the leading edge of the wing that affects pressure distribution and formation of shock waves. [Figure 5-68]

On a straight wing aircraft, the airflow strikes the wing leading edge at  $90^\circ$ , and its full impact produces pressure and lift. A wing with sweepback is struck by the same airflow at an angle smaller than  $90^\circ$ . This airflow on the swept wing has the effect of persuading the wing into believing that it is flying slower than it really is; thus the formation of shock waves is delayed. Advantages of wing sweep include an increase in critical Mach number, force divergence Mach number, and the Mach number at which drag rise peaks. In other words, sweep delays the onset of compressibility effects.

The Mach number that produces a sharp change in coefficient of drag is termed the “force divergence” Mach number and, for most airfoils, usually exceeds the critical Mach number by 5 to 10 percent. At this speed, the airflow separation induced by shock wave formation can create significant variations in the drag, lift, or pitching moment coefficients. In addition to the delay of the onset of compressibility effects, sweepback reduces the magnitude in the changes of drag, lift, or moment coefficients. In other words, the use of sweepback “softens” the force divergence.

A disadvantage of swept wings is that they tend to stall at the wingtips rather than at the wing roots. [Figure 5-69] This is

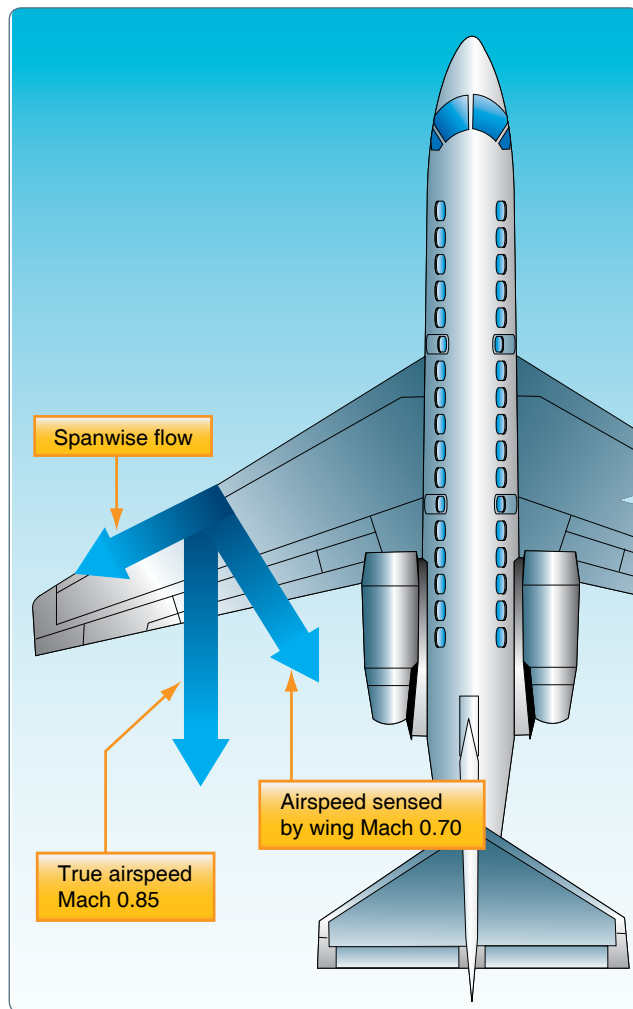
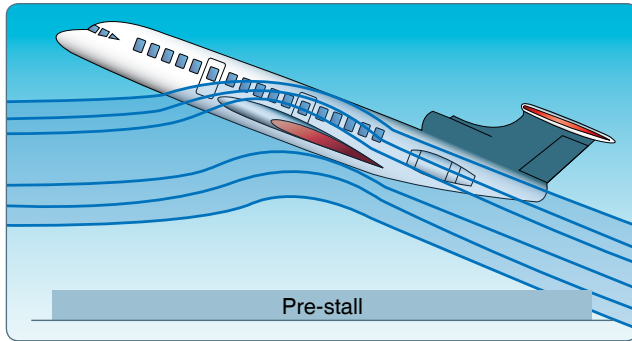

Figure 5-68. Sweepback effect.

because the boundary layer tends to flow spanwise toward the tips and to separate near the leading edges. Because the tips of a swept wing are on the aft part of the wing (behind the CL), a wingtip stall causes the CL to move forward on the wing, forcing the nose to rise further. The tendency for tip stall is greatest when wing sweep and taper are combined.

The stall situation can be aggravated by a T-tail configuration, which affords little or no pre-stall warning in the form of tail control surface buffet. [Figure 5-70] The T-tail, being above the wing wake remains effective even after the wing has begun to stall, allowing the pilot to inadvertently drive the wing into a deeper stall at a much greater AOA. If the horizontal tail surfaces then become buried in the wing’s wake, the elevator may lose all effectiveness, making it impossible to reduce pitch attitude and break the stall. In the pre-stall and immediate post-stall regimes, the lift/drag qualities of a swept wing aircraft (specifically the enormous increase in drag at low speeds) can cause an increasingly descending flight path with no change in pitch attitude, further increasing the





**Figure 5-69.** *Wingtip pre-stall.*

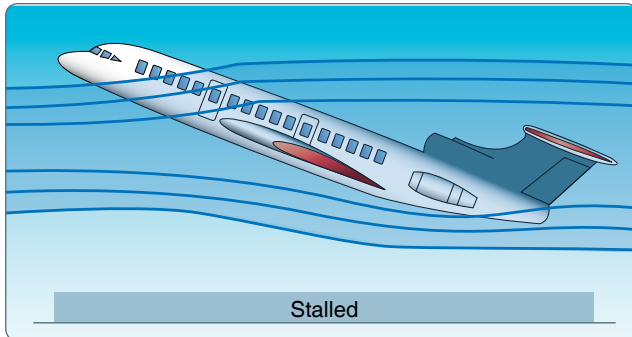

**Figure 5-70.** *T-tail stall.*

AOA. In this situation, without reliable AOA information, a nose-down pitch attitude with an increasing airspeed is no guarantee that recovery has been affected, and up-elevator movement at this stage may merely keep the aircraft stalled.

It is a characteristic of T-tail aircraft to pitch up viciously when stalled in extreme nose-high attitudes, making recovery difficult or violent. The stick pusher inhibits this type of stall. At approximately one knot above stall speed, pre-programmed stick forces automatically move the stick forward, preventing the stall from developing. A G-limiter may also be incorporated into the system to prevent the pitch down generated by the stick pusher from imposing excessive loads on the aircraft. A “stick shaker,” on the other hand, provides stall warning when the airspeed is five to seven percent above stall speed.

### Mach Buffet Boundaries

Mach buffet is a function of the speed of the airflow over the wing—not necessarily the speed of the aircraft. Any time that too great a lift demand is made on the wing, whether from too fast an airspeed or from too high an AOA near the  $M_{MO}$ , the “high-speed” buffet occurs. There are also occasions when the buffet can be experienced at much lower speeds known as the “low-speed Mach buffet.”

An aircraft flown at a speed too slow for its weight and altitude necessitating a high AOA is the most likely situation

to cause a low-speed Mach buffet. This very high AOA has the effect of increasing airflow velocity over the upper surface of the wing until the same effects of the shock waves and buffet occur as in the high-speed buffet situation. The AOA of the wing has the greatest effect on inducing the Mach buffet at either the high-speed or low-speed boundaries for the aircraft. The conditions that increase the AOA, the speed of the airflow over the wing, and chances of Mach buffet are:

- High altitudes—the higher an aircraft flies, the thinner the air and the greater the AOA required to produce the lift needed to maintain level flight.
- Heavy weights—the heavier the aircraft, the greater the lift required of the wing, and all other factors being equal, the greater the AOA.
- G loading—an increase in the G loading on the aircraft has the same effect as increasing the weight of the aircraft. Whether the increase in G forces is caused by turns, rough control usage, or turbulence, the effect of increasing the wing’s AOA is the same.

### High Speed Flight Controls

On high-speed aircraft, flight controls are divided into primary flight controls and secondary or auxiliary flight controls. The primary flight controls maneuver the aircraft about the pitch, roll, and yaw axes. They include the ailerons, elevator, and rudder. Secondary or auxiliary flight controls include tabs, leading edge flaps, trailing edge flaps, spoilers, and slats.

Spoilers are used on the upper surface of the wing to spoil or reduce lift. High speed aircraft, due to their clean low drag design, use spoilers as speed brakes to slow them down. Spoilers are extended immediately after touchdown to dump lift and thus transfer the weight of the aircraft from the wings onto the wheels for better braking performance. [Figure 5-71]

Jet transport aircraft have small ailerons. The space for ailerons is limited because as much of the wing trailing edge as possible is needed for flaps. Also, a conventional size aileron would cause wing twist at high speed. For that reason, spoilers are used in unison with ailerons to provide additional roll control.

Some jet transports have two sets of ailerons, a pair of outboard low-speed ailerons and a pair of high-speed inboard ailerons. When the flaps are fully retracted after takeoff, the outboard ailerons are automatically locked out in the faired position.

When used for roll control, the spoiler on the side of the up-going aileron extends and reduces the lift on that side, causing the wing to drop. If the spoilers are extended as speed brakes, they can still be used for roll control. If they are the

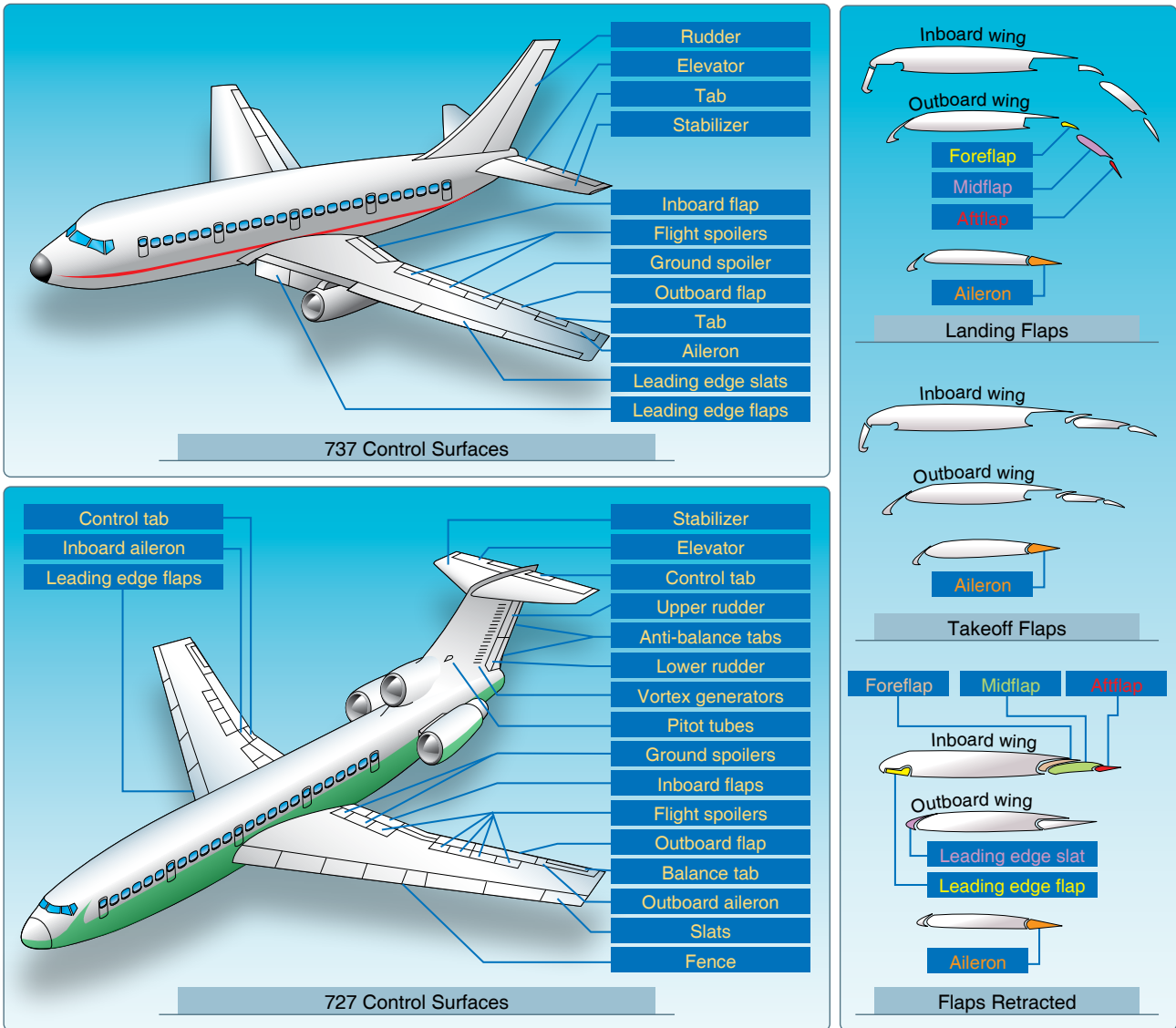

Figure 5-71. Control surfaces.

differential type, they extend further on one side and retract on the other side. If they are the non-differential type, they extend further on one side but do not retract on the other side. When fully extended as speed brakes, the non-differential spoilers remain extended and do not supplement the ailerons.

To obtain a smooth stall and a higher AOA without airflow separation, the wing's leading edge should have a well-rounded almost blunt shape that the airflow can adhere to at the higher AOA. With this shape, the airflow separation starts at the trailing edge and progresses forward gradually as AOA is increased.

The pointed leading edge necessary for high-speed flight results in an abrupt stall and restricts the use of trailing edge flaps because the airflow cannot follow the sharp curve

around the wing leading edge. The airflow tends to tear loose rather suddenly from the upper surface at a moderate AOA. To utilize trailing edge flaps, and thus increase the  $C_{L-MAX}$ , the wing must go to a higher AOA without airflow separation. Therefore, leading edge slots, slats, and flaps are used to improve the low-speed characteristics during takeoff, climb, and landing. Although these devices are not as powerful as trailing edge flaps, they are effective when used full span in combination with high-lift trailing edge flaps. With the aid of these sophisticated high-lift devices, airflow separation is delayed and the  $C_{L-MAX}$  is increased considerably. In fact, a 50 knot reduction in stall speed is not uncommon.

The operational requirements of a large jet transport aircraft necessitate large pitch trim changes. Some requirements are:

- A large CG range
- A large speed range
- The ability to perform large trim changes due to wing leading edge and trailing edge high-lift devices without limiting the amount of elevator remaining
- Maintaining trim drag to a minimum

These requirements are met by the use of a variable incidence horizontal stabilizer. Large trim changes on a fixed-tail aircraft require large elevator deflections. At these large deflections, little further elevator movement remains in the same direction. A variable incidence horizontal stabilizer is designed to take out the trim changes. The stabilizer is larger than the elevator, and consequently does not need to be moved through as large an angle. This leaves the elevator streamlining the tail plane with a full range of movement up and down. The variable incidence horizontal stabilizer can be set to handle the bulk of the pitch control demand, with the elevator handling the rest. On aircraft equipped with a variable incidence horizontal stabilizer, the elevator is smaller and less effective in isolation than it is on a fixed-tail aircraft. In comparison to other flight controls, the variable incidence horizontal stabilizer is enormously powerful in its effect.

Because of the size and high speeds of jet transport aircraft, the forces required to move the control surfaces can be beyond the strength of the pilot. Consequently, the control surfaces are actuated by hydraulic or electrical power units. Moving the controls in the flight deck signals the control angle required, and the power unit positions the actual control surface. In the event of complete power unit failure, movement of the control surface can be affected by manually controlling the control tabs. Moving the control tab upsets the aerodynamic balance, which causes the control surface to move.

## Chapter Summary

In order to sustain an aircraft in flight, a pilot must understand how thrust, drag, lift, and weight act on the aircraft. By understanding the aerodynamics of flight, how design, weight, load factors, and gravity affect an aircraft during flight maneuvers from stalls to high speed flight, the pilot learns how to control the balance between these forces. For information on stall speeds, load factors, and other important aircraft data, always consult the AFM/POH for specific information pertaining to the aircraft being flown.