

Conservation of Energy

- In which of the following is the total amount of energy conserved? (Select all that apply)
 - A system
 - The universe
 - An isolated system
 - A non-isolated system
- A ball is dropped from some height and lands on a spring, compressing it by some amount. Which of the following could be defined as the system in this scenario? (Select all that apply)
 - The ball
 - The ball and the earth
 - The ball and the spring
 - The spring and the earth
- True or false: It's possible for the total amount of kinetic energy within an isolated system to increase over time.
- A block is attached to a vertical spring and oscillates up and down. If we define the system as only the block, which of the following are in the environment?
 - The spring
 - The block
 - The earth
 - None of the above
- A ball is dropped and falls down due to gravity. Which of the following is true about the isolated ball-earth system? (Select all that apply)
 - The total amount of kinetic energy in the system is conserved
 - The total amount of gravitational potential energy in the system is conserved
 - The total amount of energy in the system is conserved
 - None of the above
- If a system is an isolated system... (Select all that apply)
 - energy can enter or leave the system
 - no work is done on the system or by the system
 - there are no net external forces acting on the system
 - there are no forces acting between objects inside the system
- A block slides down an incline and into a spring, compressing it some amount. If we define the system to include the block and the spring, which of the following are internal forces? (Select all that apply)
 - The spring force exerted on the block by the spring
 - The weight force on the block
 - The normal force acting on the block from the ground
 - The force exerted on the spring by the block

8. If the amount of gravitational potential energy decreases in an isolated system, which of the following must be true? (Select all that apply)
- A The amount of kinetic energy in the system increases
 - B The total amount of energy in the system stays the same
 - C The amount of gravitational potential energy in the environment increases
 - D The amount of other types of energy in the system increase
9. A block slides across rough ground and comes to a stop. If we define the system as the block and the ground, which of the following could explain why the block stops moving?
- A The friction force between the block and the ground is an internal force which transfers energy from the system to the environment
 - B The friction force between the block and the ground is an external force which transfers energy from the system to the environment
 - C The friction force between the block and the ground is an internal force which decreases the kinetic energy in the system and increases the thermal energy in the system
 - D The friction force between the block and the ground is an external force which decreases the kinetic energy in the system and increases the thermal energy in the system
10. At one moment in time, an isolated system has 5 J of kinetic energy and 12 J of gravitational potential energy, and no other energy. 10 seconds later, which of the following is true about the system? (Select all that apply)
- A It has 5 J of kinetic energy
 - B It has 12 J of gravitational potential energy
 - C It has 12 J of kinetic energy
 - D It has 17 J of total energy
11. A block is dropped from some height and lands on a vertical spring, compressing it some amount before it reverses direction and moves upwards. If we define the system as the block, which of the following are external forces? (Select all that apply)
- A The weight force on the block
 - B The spring force on the block
 - C The force exerted on the spring by the block
 - D None of the above
12. A ball of mass m is dropped from rest from a height of y_1 . What is the speed of the ball when it reaches a height of y_2 (not using kinematics)?
- A mgy_1
 - B $\sqrt{2g(y_1 - y_2)}$
 - C mgy_2
 - D $\sqrt{2g(y_2 - y_1)}$
13. A block is hanging from a vertical spring. The block is lifted and released so it oscillates up and down. When the block is at the middle of the oscillation it has 20 J of kinetic energy, 30 J of gravitational potential energy and 10 J of spring potential energy. When the block is at the bottom of the oscillation it's momentarily at rest and has 40 J of spring potential energy. How much gravitational potential energy does it have at that time?
- A 20 J
 - B 30 J
 - C 40 J
 - D 60 J

14. A block is sliding across a frictionless surface with a speed of v when it contacts a spring and compresses it by a displacement of Δx_1 before momentarily coming to a stop and reversing direction. If a different block with twice the mass but the same speed slid into the spring, how much would the spring compress in terms of Δx_1 ?
- A $\Delta x_1/2$
 - B $2\Delta x_1$
 - C $4\Delta x_1$
 - D $\sqrt{2}\Delta x_1$

15. A block is sitting at rest on a spring which is compressed some amount from its original length. The system is defined by the dotted line shown on the right. Which of the following types of energy exist inside the system? (Select all that apply)

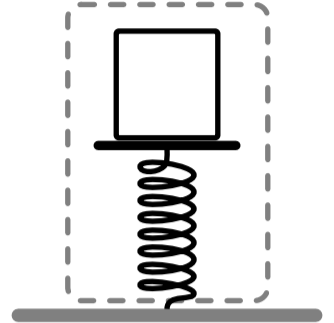

- A Kinetic energy
 - B Spring potential energy
 - C Gravitational potential energy
 - D None of the above
16. A ball is at rest at position A, rolls without slipping down an incline and compresses a spring until it momentarily comes to a stop (position C) as shown on the right. If we define the system as the ball, the spring and the earth, and the ground is the zero reference for gravitational potential energy, what types of energy exist in the system when the ball is at position A? (Select all that apply)

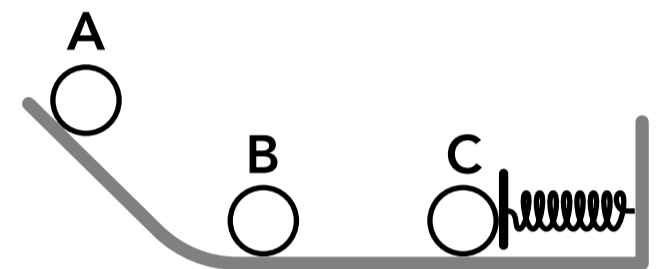
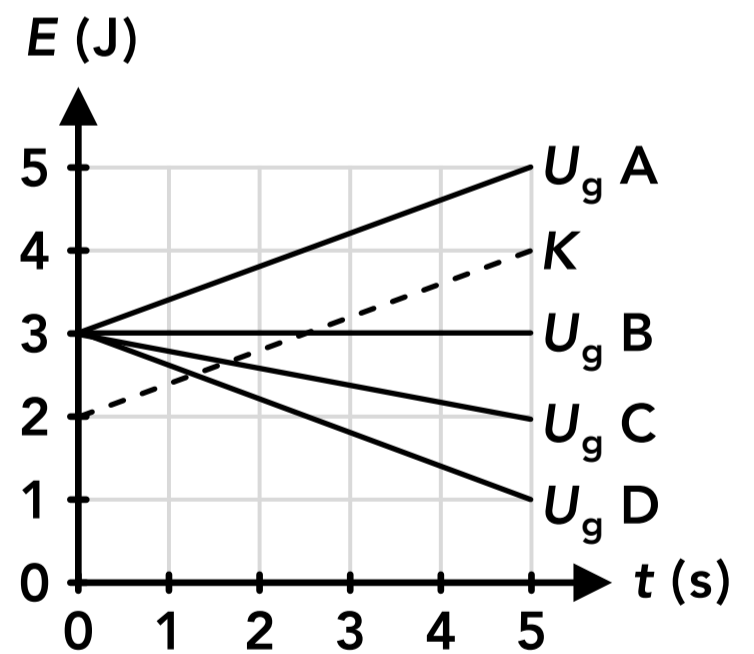

Figure 1

- A Kinetic energy
 - B Spring potential energy
 - C Rotational kinetic energy
 - D Gravitational potential energy
17. The graph of the energy in an isolated system is shown on the right. The kinetic energy is shown with a dotted line, and four possible graphs of the gravitational potential energy are shown with solid lines. If the system has no other types of energy, which is the correctly line for the gravitational potential energy?



- A Line A
 - B Line B
 - C Line C
 - D Line D
18. A ball is dropped from rest from a height of 6 m. At what height will the ball have a speed of 8 m/s (without using kinematics)?

19. A 50 g ball is placed into a spring loaded gun. The spring is compressed 10 cm and has a spring constant of 500 N/m. The spring is then released to its original length and the ball is launched vertically into the air. How high above its initial height (inside the gun) does the ball travel?

20. At one point in a roller coaster ride the car is 12 m above the ground and moving at 8 m/s. The car goes through a steep drop and then a vertical loop. If the car is 14 m above the ground at the top of the loop, how fast is it moving? Assume there is no friction or air resistance.

21. A pendulum consisting of an 80 cm long string with negligible mass and a ball is at its highest point in the swing at the position shown on the right. What is the speed of the ball at the lowest point in the swing when the string is vertical?

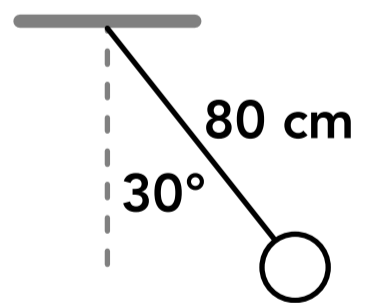

22. A block is sliding on a frictionless surface when it contacts a spring and begins to compress it. If the block is still moving at 1 m/s when it compresses the spring by 15 cm, what is the spring constant?

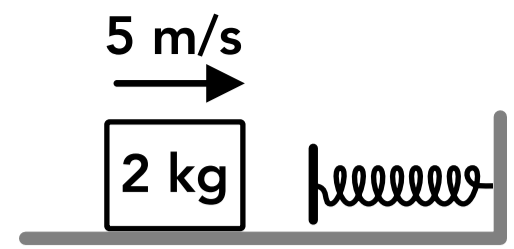

23. A rope is wrapped around a pulley which is attached to the ceiling. One end of the rope is attached to a spring with a spring constant of 150 N/m and a 4 kg block is attached to the other end. When the block is released, what distance does it fall before it momentarily comes to rest and reverses direction?

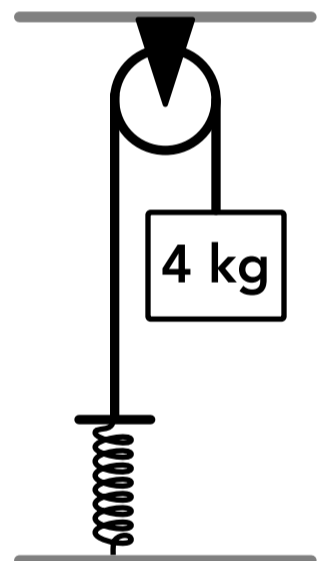

Work

24. If work is done on a system, which of the following is true? (Select all that apply)
- A The system is isolated
 - B The total amount of energy in the system increases
 - C The system is not isolated
 - D The total amount of energy in the system decreases
25. What is the SI unit for work?
- A N
 - B J
 - C m
 - D kg
26. What type of forces can do work on a system?
- A Internal forces
 - B External forces
 - C Either internal or external forces
 - D None of the above
27. If a system does work on the environment, which of the following is true? (Select all that apply)
- A The total amount of energy in the system decreases
 - B The total amount of energy in the system is conserved
 - C The total amount of energy in the environment increases
 - D The total amount of energy in the environment decreases
28. A block is sitting at rest on the ground when a force is exerted on the block which causes it to move. The amount of work done on the block by the force depends on which of the following? (Select all that apply)
- A The magnitude of the force
 - B The mass of the block
 - C The direction of the force
 - D The displacement of the block
29. A system has 15 J of gravitational potential energy, 8 J of kinetic energy and 20 J of spring potential energy (and no other types of energy). If 10 J of work is done on the system, how much energy will the system have?
- A 10 J
 - B 33 J
 - C 43 J
 - D 53 J
30. A block slides across the ground and comes to a stop. If we define the system as the block, which of the following forces do work on the system (or result in work being done by the system)? (Select all that apply)
- A The weight force on the block
 - B The normal force on the block
 - C The friction force on the block
 - D None of the above

31. A person holds a book in the air at rest and then lifts it vertically until it is again at rest. Which of the following is true about the book-earth system? (Select all that apply)
- A The force from the person's hand does positive work on the system
 - B The gravitational force on the book does negative work on the system
 - C The system's energy is conserved
 - D The total amount of work done on the system is zero
32. A block is held at some height above a vertical spring mounted to the floor. The block is released, falls down and lands on the spring, compressing it some amount. If we define the system as the block, which of the following types of energy does the system have at some point in this scenario? (Select all that apply)
- A Gravitational potential energy
 - B Kinetic energy
 - C Spring potential energy
 - D None of the above
33. A block is hanging from a vertical spring at rest. If we define the system as the block, which of the following forces do work on the block?
- A The weight force
 - B The spring force
 - C The weight force and the spring force
 - D None of the above
34. A block slides across a rough floor and contacts a spring, compressing it some amount. Which of the following is true about the block-spring system? (Select all that apply)
- A The block does work on the spring
 - B The floor does work on the system
 - C Kinetic energy is converted into spring potential energy
 - D The spring does work on the block
35. A block is at rest on a frictionless surface when it's pulled to the right by a rope with a tension force T at an angle. When the block has been pulled to the right a displacement of d it has kinetic energy K . Which of the following is equal to that displacement?
- A $T\cos(\theta)K$
 - B $\frac{T}{m}$
 - C $\frac{K}{T\cos(\theta)}$
 - D TmK

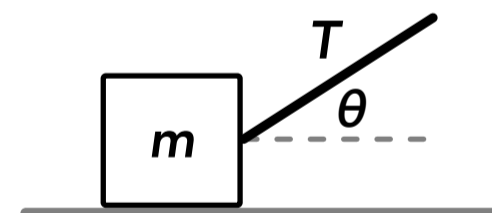

36. A graph of the energies in a system is shown on the right. No other types of energy exist in the system. Which of the following is true? (Select all that apply)

- A The system is isolated
- B Work is done on the system by the environment
- C The system is not isolated
- D Work is done by the system on the environment

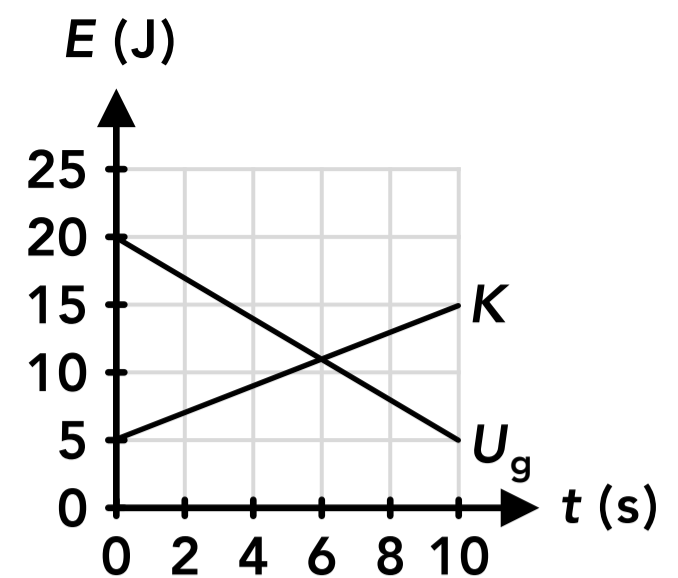

37. While a ball is falling down, an upwards tension force is exerted on the ball as shown on the right. Which of the following is true about the ball system?

- A The tension force does positive work on the ball
- B The tension force does negative work on the ball
- C The tension force does zero total work on the ball
- D The tension force cannot do work on the ball

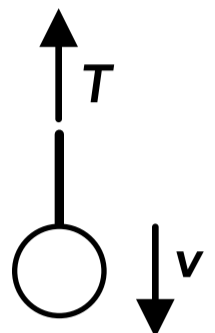

38. A 4 kg ball is falling at a speed of 2 m/s. A few seconds later the ball is falling at 10 m/s. How much work is done on the ball by gravity during that period of time?

39. A block moves 6 m to the left due to a 20 N tension force as shown on the right. How much work is done by the tension force?

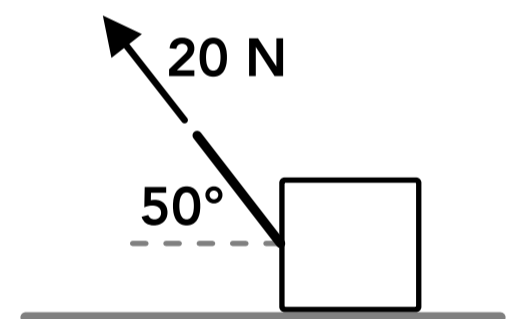

40. A 5 kg block is at rest at the top of an incline as shown on the right. The block slides down the incline and compresses a spring with a spring constant of 200 N/m. The block momentarily comes to a stop when the spring is compressed 10 cm. How much work was done on the block by friction between the block and the surface?

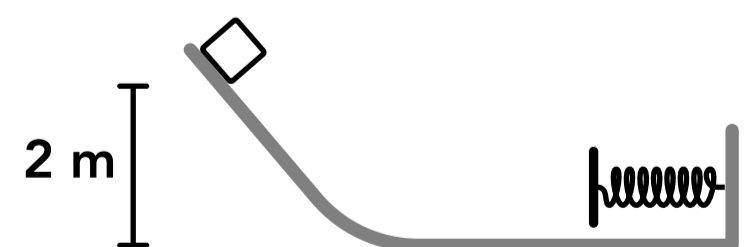

Power

41. Power can be calculated as which of the following? (Select all that apply)
- A An amount of work divided by a period of time
 - B A force multiplied by a displacement
 - C A change in energy divided by a period of time
 - D A force multiplied by a velocity
42. What is the SI unit for power?
- A J
 - B N
 - C W
 - D kg
43. A ball of mass m is released from rest and falls straight down. After a period of time Δt the ball is moving with a speed of v . During that time, how much power is exerted by gravity on the ball? (Select all that apply)
- A $\frac{mv^2}{2\Delta t}$
 - B $\frac{1}{2}mv^2$
 - C mgv
 - D $\frac{mgv}{2}$
44. A person pushes horizontally on a box of mass m to move it across the floor with a constant speed of v . The person exerts an amount of power P on the box. How much force do they apply to the box?
- A Pv
 - B $\frac{P}{v}$
 - C $\frac{1}{2}mv^2$
 - D mv
45. How much power does it take to accelerate a 1,500 kg car from 0 m/s to 27 m/s in 5 seconds?
46. 3 people, each with a mass of 80 kg, get on an elevator with a mass of 2,000 kg. The elevator begins moving upwards at a constant speed and the elevator motor is supplying 50,000 W of power. How fast is the elevator moving?
47. A block is pulled across a frictionless surface by a tension force as shown on the right for a period of 3 seconds. If the tension force exerts 30 W of power, what is the angle θ ?

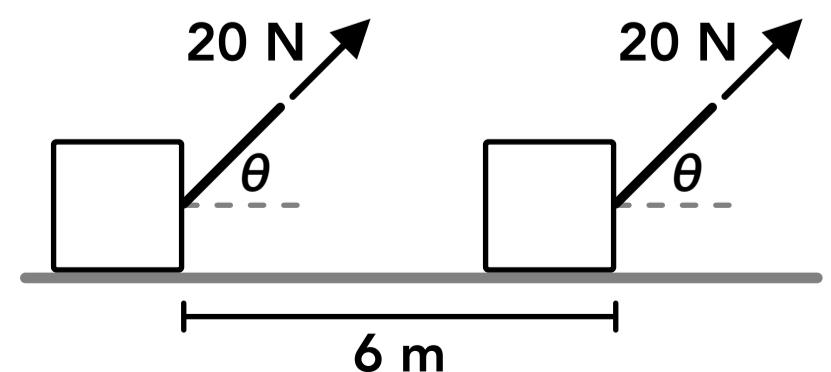

Answers

- | | | | | |
|---------------|--------------|----------------|------------|---------------|
| 1. B, C | 11. A, B, C | 21. 1.4 m/s | 31. A | 41. A, C, D |
| 2. A, B, C, D | 12. B | 22. 2133.3 N/m | 32. B | 42. C |
| 3. True | 13. A | 23. 0.52 m | 33. D | 43. A |
| 4. A, C | 14. D | 24. B, C | 34. B, C | 44. B |
| 5. C | 15. B | 25. B | 35. C | 45. 109,350 W |
| 6. B, C | 16. D | 26. B | 36. C, D | 46. 2.3 m/s |
| 7. A, D | 17. D | 27. A, C | 37. B | 47. 41.4° |
| 8. B, D | 18. 2.73 m | 28. A, C, D | 38. 192 J | |
| 9. C | 19. 5.1 m | 29. D | 39. 77.1 J | |
| 10. D | 20. 4.98 m/s | 30. C | 40. -97 J | |

Answers - Conservation of Energy

1. **Answer: B, C**

According to the law of conservation of energy, the total amount of energy in the universe or an isolated system is conserved, which means it doesn't change over time. An isolated system is defined as a system in which the total amount of energy is conserved.

2. **Answer: A, B, C, D**

We can define a system to include any objects that we want, although the system may or may not be isolated. Depending on our definition, some objects and forces will be considered internal or external.

3. **Answer: True**

The total amount of energy in an isolated system does not change over time, but the amount of each type of energy (kinetic energy, gravitational potential energy, spring potential energy, etc.) does not have to stay the same. Energy can be converted or transformed between different types within an isolated system.

4. **Answer: A, C**

When we define a system, everything in the universe is either considered inside the system or in the environment (outside of the system). Only the block is inside the system so the spring, the earth and everything in the universe besides the block is in the environment.

5. **Answer: C**

The total amount of energy in the isolated ball-earth system is conserved, but the amount of kinetic energy and gravitational potential energy changes. Gravitational potential energy is converted or transformed into kinetic energy by the internal gravitational force.

6. **Answer: B, C**

A system is isolated if no energy enters or leaves the system because no work is done on the system or by the system on the environment. This means there are no net external forces acting on the system, which would do work on the system. There can be forces between objects within the system, which are internal forces.

7. **Answer: A, D**

Internal forces are force pairs between objects that are inside the system (internal objects), so the only internal forces are the contact forces between the block and the spring. The weight force or gravitational force acting on the block from the earth is an external force. The normal force acting on the block from the ground is also an external force.

8. **Answer: B, D**

If the amount of one type of energy in an isolated system decreases, the total amount of energy in the system must stay the same (the system is isolated) so the amount of at least one other type of energy must increase. That other type does not have to be kinetic energy, it could be spring potential energy or any type of non-mechanical energy like thermal energy. The system is isolated so no energy enters or leaves the system, so the energy in the environment does not change.

9. **Answer: C**

The system includes the block and the ground so the friction force between the block and the ground is an internal force. Internal forces can convert or transform energy from one type to a different type, and in this case kinetic energy from the block is converted into thermal energy in the block and the ground. No energy leaves the system because the ground is included in the system.

10. **Answer: D**

The system is isolated so the total amount of energy in the system stays the same over time, which is 17 J. The amount of kinetic energy and gravitational potential energy can change.

11. **Answer: A, B, C**

The block and the earth are external objects so the weight of the block (the gravitational force exerted on the block by the earth) is an external force and the forces between the block and the spring are external forces.

12. **Answer: B**

If we defined the system as the ball and the earth, the gravitational force on the ball is an internal force. There are no external forces acting on the system so the system is isolated and we can use conservation of energy. The system includes gravitational potential energy and kinetic energy, and the total amount of energy is equal at the initial time and the final time (initial height and final height).

$$E_i = E_f \quad K_i + U_{gi} = K_f + U_{gf} \quad \frac{1}{2}m(0 \text{ m/s})^2 + mgy_1 = \frac{1}{2}mv_f^2 + mgy_2 \quad gy_1 = \frac{1}{2}v_f^2 + gy_2$$

$$v_f = \sqrt{2g(y_1 - y_2)}$$

13. **Answer: A**

The block is said to have spring potential energy and gravitational potential energy, which means the system includes the block, the spring and the earth. There are no net external forces acting on the system so the system is isolated and the total amount of energy in the system is conserved, which is 60 J. At this moment, the block is at rest so it has no kinetic energy, so it must have 20 J of gravitational potential energy.

14. **Answer: D**

If we define the system to include the block and the spring then there are no net external forces acting on the system and the system is isolated. We can use conservation of energy, where the initial time is before the block contacts the spring and the final time is when the block comes to a stop while compressing the spring. We get a relationship between the mass of the block and the displacement of the spring. If the mass is multiplied by 2 then the displacement must be multiplied by $\sqrt{2}$ if all the other variables are the same.

$$E_i = E_f \quad K_i + U_{sp i} = K_f + U_{sp f} \quad \frac{1}{2}mv_i^2 + \frac{1}{2}k(0 \text{ m})^2 = \frac{1}{2}m(0 \text{ m/s})^2 + \frac{1}{2}k\Delta x_f^2 \quad mv_i^2 = k\Delta x_f^2$$

15. **Answer: B**

The system includes the block and the spring but does not include the earth. If the block was moving there would be kinetic energy inside the system but the block is at rest. There is spring potential energy inside the system because the spring is compressed, and the spring is inside the system. Since the earth is not included in the system the gravitational force acting on the block from the earth is an external force and the system cannot have gravitational potential energy. The system can only have gravitational potential energy if the earth (and another object) is included in the system.

16. **Answer: D**

The ball is at rest at position A and the spring is not compressed so the system only has gravitational potential energy when the ball is at position A.

17. **Answer: D**

The system is isolated so the total amount of energy in the system stays the same over time, which is the sum of the kinetic energy and the potential energy at any time. The system starts with 2 J of kinetic energy and 3 J of gravitational potential energy, so the total energy is always 5 J. At 5 seconds, the system has 4 J of kinetic energy so it must have 1 J of gravitational potential energy. We could also say the kinetic energy increases by 2 J so the gravitational potential energy must decrease by 2 J.

18. **Answer: 2.73 m**

The total amount of energy is conserved in the ball-earth system. We can say $y = 0$ at the ground.

$$E_i = E_f \quad K_i + U_{g_i} = K_f + U_{g_f} \quad \frac{1}{2}m(0 \text{ m/s})^2 + mg(6 \text{ m}) = \frac{1}{2}m(8 \text{ m/s})^2 + mgy_f \quad y_f = 2.73 \text{ m}$$

19. **Answer: 5.1 m**

The total amount of energy is conserved in the ball-spring-earth system. We can say $y = 0$ at the initial height.

$$E_i = E_f \quad K_i + U_{g_i} + U_{sp_i} = K_f + U_{g_f} + U_{sp_f} \quad \frac{1}{2}m(0)^2 + mg(0) + \frac{1}{2}k(0.1 \text{ m})^2 = \frac{1}{2}m(0)^2 + mgy_f + \frac{1}{2}k(0)^2$$

$$\frac{1}{2}(500 \text{ N/m})(0.1 \text{ m})^2 = (0.05 \text{ kg})gy_f \quad y_f = 5.1 \text{ m}$$

20. **Answer: 4.98 m/s**

The total amount of energy is conserved in the car-earth system. We can say $y = 0$ at the ground.

$$E_i = E_f \quad K_i + U_{g_i} = K_f + U_{g_f} \quad \frac{1}{2}m(8 \text{ m/s})^2 + mg(12 \text{ m}) = \frac{1}{2}mv_f^2 + mg(14 \text{ m}) \quad v_f = 4.98 \text{ m/s}$$

21. **Answer: 1.4 m/s**

The total amount of energy is conserved in the pendulum-earth system. At the position shown the ball is momentarily not moving because it's at the highest point in the swing (the pendulum is reversing direction). The difference in height between the position shown and the lowest point can be found using trigonometry.

$\Delta y = (80 \text{ cm}) - (80 \text{ cm})\cos(30^\circ) = 10.72 \text{ cm}$, we can say $y = 0$ at the lowest point

$$E_i = E_f \quad K_i + U_{g_i} = K_f + U_{g_f} \quad \frac{1}{2}m(0)^2 + mg(0.1072 \text{ m}) = \frac{1}{2}mv_f^2 + mg(0 \text{ m}) \quad v_f = 1.4 \text{ m/s}$$

22. **Answer: 2133.3 N/m**

The total amount of energy is conserved in the block-spring system.

$$E_i = E_f \quad K_i + U_{sp_i} = K_f + U_{sp_f} \quad \frac{1}{2}(2 \text{ kg})(5 \text{ m/s})^2 + \frac{1}{2}k(0 \text{ m})^2 = \frac{1}{2}(2 \text{ kg})(1 \text{ m/s})^2 + \frac{1}{2}k(0.15 \text{ m})^2$$

$$k = 2133.3 \text{ N/m}$$

23. **Answer: 0.52 m**

The distance that the block falls is the same distance than the spring is stretched upwards because they are connected by the rope. This problem cannot be solved by finding the distance the block falls when the weight of the block is equal to the spring force. The block will fall farther than that distance because it still has inertia of kinetic energy at that point. We can solve it using conservation of energy for the block-spring-earth system. We can say that for the block, $y = 0$ at its initial point. For the spring, $\Delta y_f = \Delta y = y_f$.

$$E_i = E_f \quad U_{g_i} + U_{sp_i} = U_{g_f} + U_{sp_f} \quad (4 \text{ kg})g(0) + \frac{1}{2}(150 \text{ N/m})(0 \text{ m})^2 = (4 \text{ kg})gy_f + \frac{1}{2}(150 \text{ N/m})y_f^2$$

$$y_f = -0.52 \text{ m}$$

Answers - Work

24. **Answer: B, C**

If work is done on a system, energy is transferred from the environment to the system so the system is not isolated and the total amount of energy in the system increases.

25. **Answer: B**

The SI unit for work is a joule (J), the same as the unit for energy because work is just a change in energy. 1 J is equal to 1 N·m.

26. **Answer: B**

Only external forces (forces between an object in the system and an object outside the system) can do work and transfer energy into or out of a system. Internal forces only convert or transform energy within a system.

27. **Answer: A, C**

The a system does work on the environment, energy is transferred from the system to the environment so the total amount of energy in the system decreases and the total amount of energy in the environment increases.

28. **Answer: A, C, D**

The amount of work done by a force which moves an object or system some displacement is given by the equation below. Only the component of the force which is parallel to the displacement of the object does work.

$$W = F_{\parallel} d$$

29. **Answer: D**

The system starts with a total of 43 J of energy. If 10 J of work is done on the system then 10 J of energy is added to the system and it ends up with 53 J of energy.

30. **Answer: C**

The weight force, normal force and friction force are all external forces (which could do work on a system) but only a force which has a component parallel to the displacement of the system does work on the system (or results in work being done by the system). Only the friction force between the block and the ground does work because it's parallel to the displacement of the block. Energy is transferred from the block system to the environment so we would say work is done by the system due to the friction force.

31. **Answer: A**

The system is defined as the book and the earth, so only the force from the person's hand is an external force which can do work on the system. The person increases the system's total energy (gravitational potential energy) so the person does positive work on the system. The gravitational force on the book is an internal force (because the earth is in the system) so it cannot do work on the system.

32. **Answer: B**

The system is defined as only including the block so the system cannot have gravitational potential energy or spring potential energy, only kinetic energy. The gravitational force and the spring force acting on the block are external forces which do work on the block system and change its kinetic energy.

33. **Answer: D**

The weight force and spring force are external forces which could do work on the system, but the block is at rest and its displacement is zero, so no work is done on the system.

34. **Answer: B, C**

The system is defined as the block and the spring, so any forces between the block and spring are internal forces which can convert energy within the system (from kinetic energy to spring potential energy) but cannot do work on the system. The friction force on the block from the floor is an external force which does work on the system.

35. **Answer: C**

The component of the tension force which is parallel to the displacement of the block (the horizontal component) does work on the block which is equal to the change in kinetic energy (which is just the final kinetic energy since the block starts at rest).

$$W = \Delta E = K_f - K_i = K \quad W = F_{\parallel} d = T \cos(\theta) d \quad T \cos(\theta) d = K \quad d = \frac{K}{T \cos(\theta)}$$

36. **Answer: C, D**

The total amount of energy in the system decreases over time, from 25 J to 20 J, so work is done by the system on the environment and the system is not isolated.

37. **Answer: B**

As the ball falls the displacement of the ball is downwards and the tension force acts upwards so the tension force does negative work on the ball.

38. **Answer: 192 J**

The amount of work done on the ball system by the gravitational force on the ball is equal to the change in energy of the ball system, which is only kinetic energy. The ball system does not have gravitational potential energy because the earth is not included in the system (gravity is an external force that does work on the system).

$$W = \Delta E = K_f - K_i = \frac{1}{2}(4 \text{ kg})(10 \text{ m/s})^2 - \frac{1}{2}(4 \text{ kg})(2 \text{ m/s})^2 = 192 \text{ J}$$

39. **Answer: 77.1 J**

Only the component of the tension force which is parallel to the displacement does work, which is the horizontal component. The force component acts in the same direction as the displacement so the work is positive.

$$W = F_{\parallel} d = (20 \text{ N}) \cos(50^\circ)(6 \text{ m}) = 77.1 \text{ J}$$

40. **Answer: -97 J**

If we define the system to include the block, the spring and the earth (but not the incline or surface) then the change in the system's energy is equal to the work done on the system by the friction force on the block. The block is not moving at the initial and final points so it has no kinetic energy. We can say $y = 0$ at the ground.

$$W = \Delta E = E_f - E_i = (U_{g f} + U_{sp f}) - (U_{g i}) = (5 \text{ kg})g(0 \text{ m}) + \frac{1}{2}(200 \text{ N/m})(0.1 \text{ m})^2 - (5 \text{ kg})g(2 \text{ m}) = -97 \text{ J}$$

Answers - Power

41. **Answer: A, C, D**

Power is the amount of work done on or by a system divided by a period of time, which is also the change in energy of a system divided by a period of time. If a force is applied to a system that is moving, power can also be calculated as the component of the force which is parallel to the velocity multiplied by the velocity.

42. **Answer: C**

The SI unit for power is a watt (W) which is equal to 1 J/s.

43. **Answer: A**

The amount of power exerted by gravity is equal to the work done on the ball by gravity divided by the period of time. That work is equal to the change in energy, which in this case is only the change in kinetic energy. The ball system does not have gravitational potential energy because gravity is considered an external force.

$$P = \frac{W}{\Delta t} = \frac{\Delta E}{\Delta t} = \frac{\Delta K}{\Delta t} = \frac{\frac{1}{2}mv^2 - \frac{1}{2}m(0 \text{ m/s})^2}{\Delta t} = \frac{mv^2}{2\Delta t}$$

44. **Answer: B**

The power is equal to the force applied by the person multiplied by the velocity of the box.

$$P = Fv \quad F = \frac{P}{v}$$

45. **Answer: 109,350 W**

The power is equal to the change in energy of the car, which is the change in kinetic energy.

$$P = \frac{W}{\Delta t} = \frac{\Delta E}{\Delta t} = \frac{\Delta K}{\Delta t} = \frac{\frac{1}{2}(1,500 \text{ kg})(27 \text{ m/s})^2 - \frac{1}{2}(1,500 \text{ kg})(0 \text{ m/s})^2}{(5 \text{ s})} = 109,350 \text{ W}$$

46. **Answer: 2.3 m/s**

The power from the elevator motor is equal to the force needed to lift the elevator and people at a constant speed, which is equal to the weight of the elevator and people.

$$P = F_{\parallel}v \quad (50,000 \text{ W}) = (2,240 \text{ kg})gv \quad v = 2.3 \text{ m/s}$$

47. **Answer: 41.4°**

The power exerted by the tension force is equal to the work done by the tension force divided by the period of time. Only the horizontal component of the tension force does work.

$$P = \frac{W}{\Delta t} = \frac{F_{\parallel}d}{\Delta t} \quad (30 \text{ W}) = \frac{(20 \text{ N})\cos(\theta)(6 \text{ m})}{(3 \text{ s})} \quad \theta = 41.4^{\circ}$$