

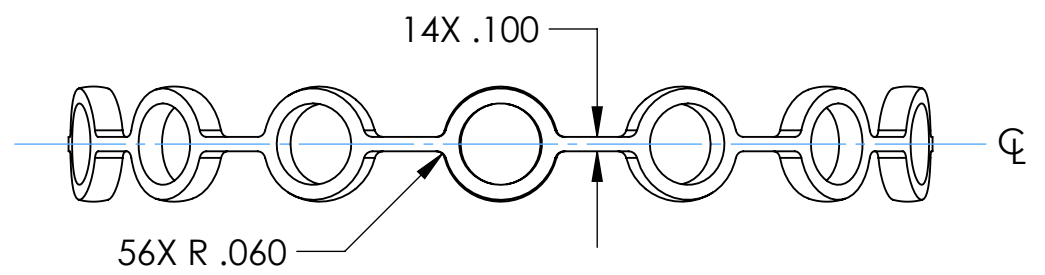

Model File Name: ATP-030

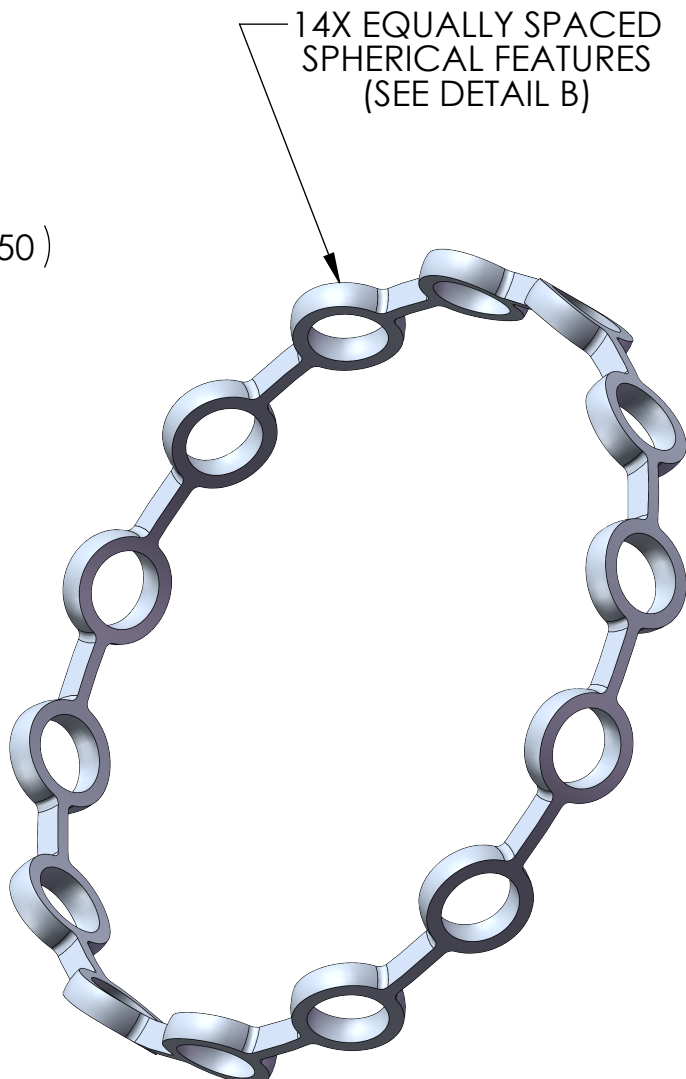
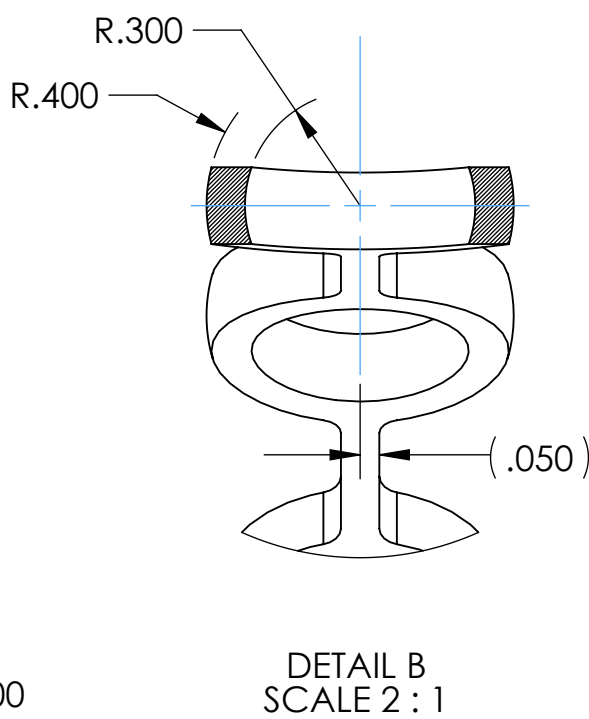
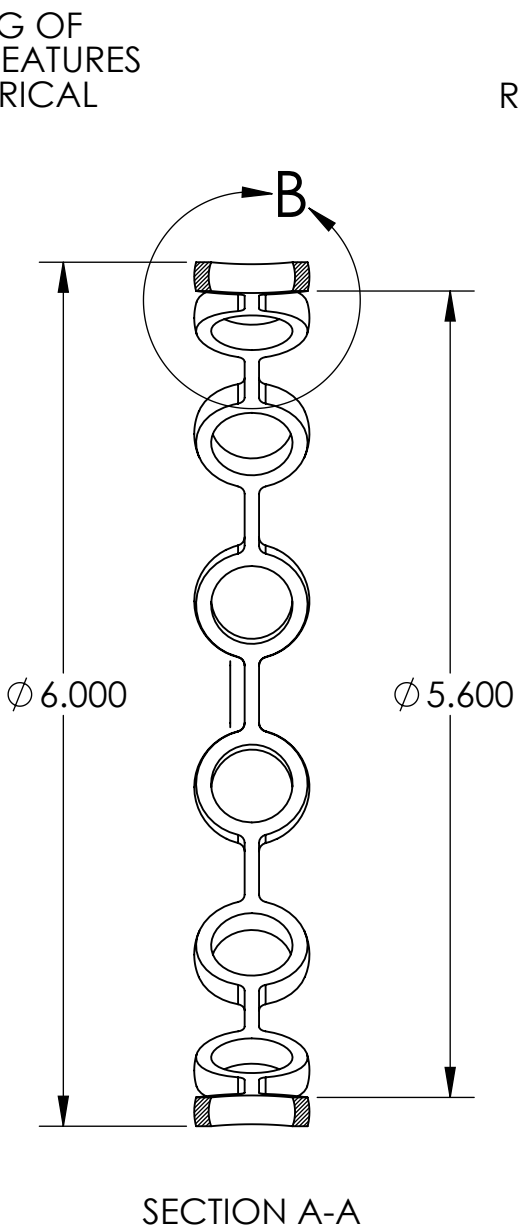
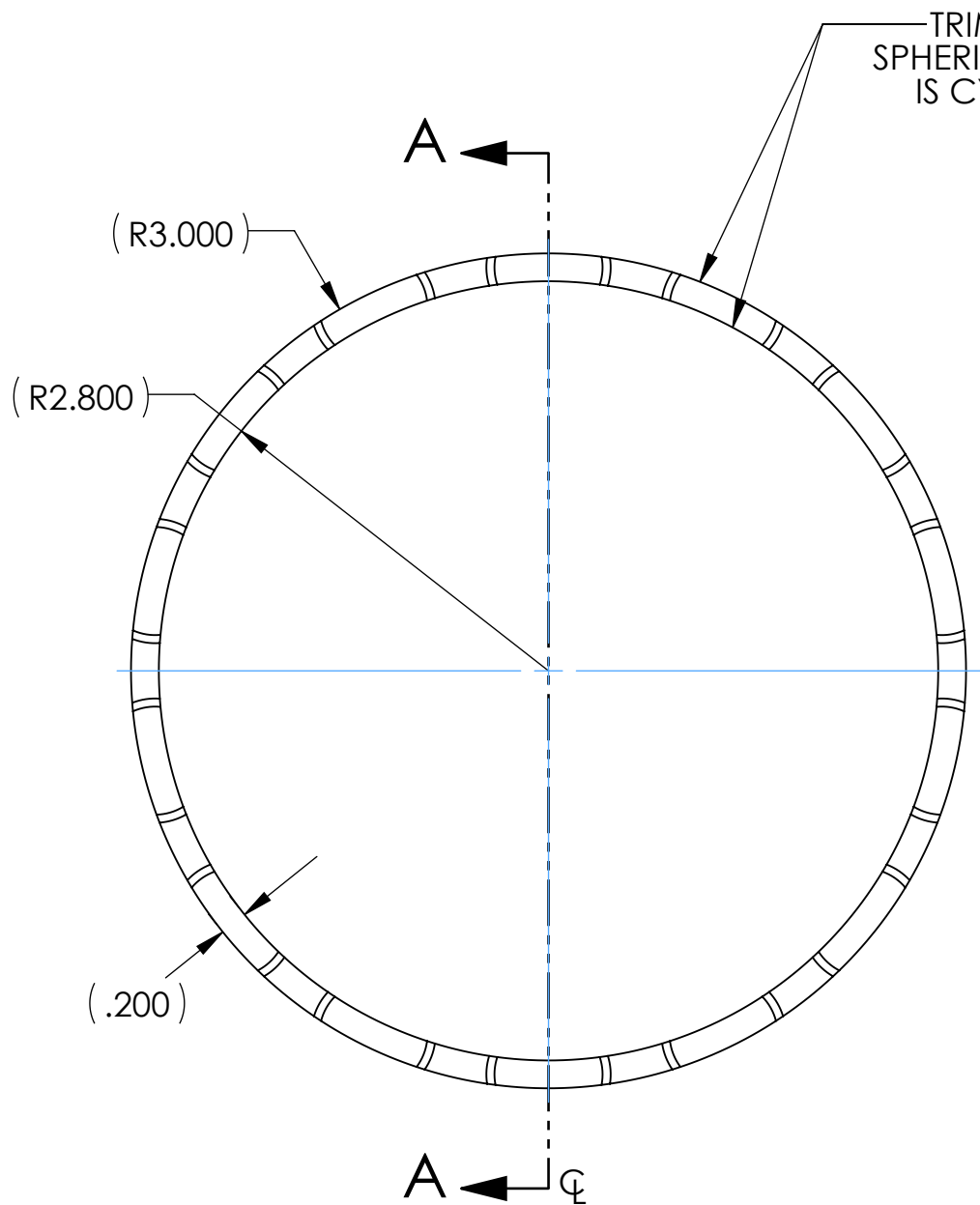
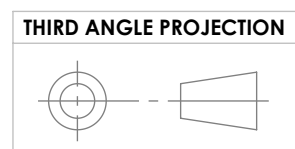

- NOTES:
1. DRAWING TO BE INTERPRETED IN ACCORDANCE WITH ASME Y14.5-2018
 2. MATERIAL: GRAY CAST IRON
 3. DENSITY: 7,200 kg/m³
 4. VOLUME: 0.765 CUBIC INCHES
 5. MASS: 0.199 LBS

DIMENSIONS IN INCHES
PART IS SYMMETRIC ABOUT \varnothing



 <p>Agile Academy agile-academy.tech</p>	
<p>DO NOT SCALE PRINT</p> <p>TOLERANCES UNLESS OTHERWISE SPECIFIED</p> <p>.XX ± .01 .XXX ± .005 ANGLE ± .5°</p> <p>SIZE B</p>	
<p>DRAWN BY JEV</p> <p>CHECKED BY JLM</p>	<p>PATTERN 01 SAMPLE PARTS</p> <p>DRAWING NO. ATP-030</p> <p>SCALE: 3:4 DATE 1/22/2025 SHEET 1 OF 1</p>